

**Enkeboll Foundation for the Arts & Architecture**

Sponsored Project:

**Architectural Restoration and Conservation (ARC) of Carved-Wood Interiors**

Final Report Volume 1

Carnegie Mellon University, School of Architecture

Administrator: Laura Lee

Lead Faculty: Kai Gutschow

Date: 11 November 2005

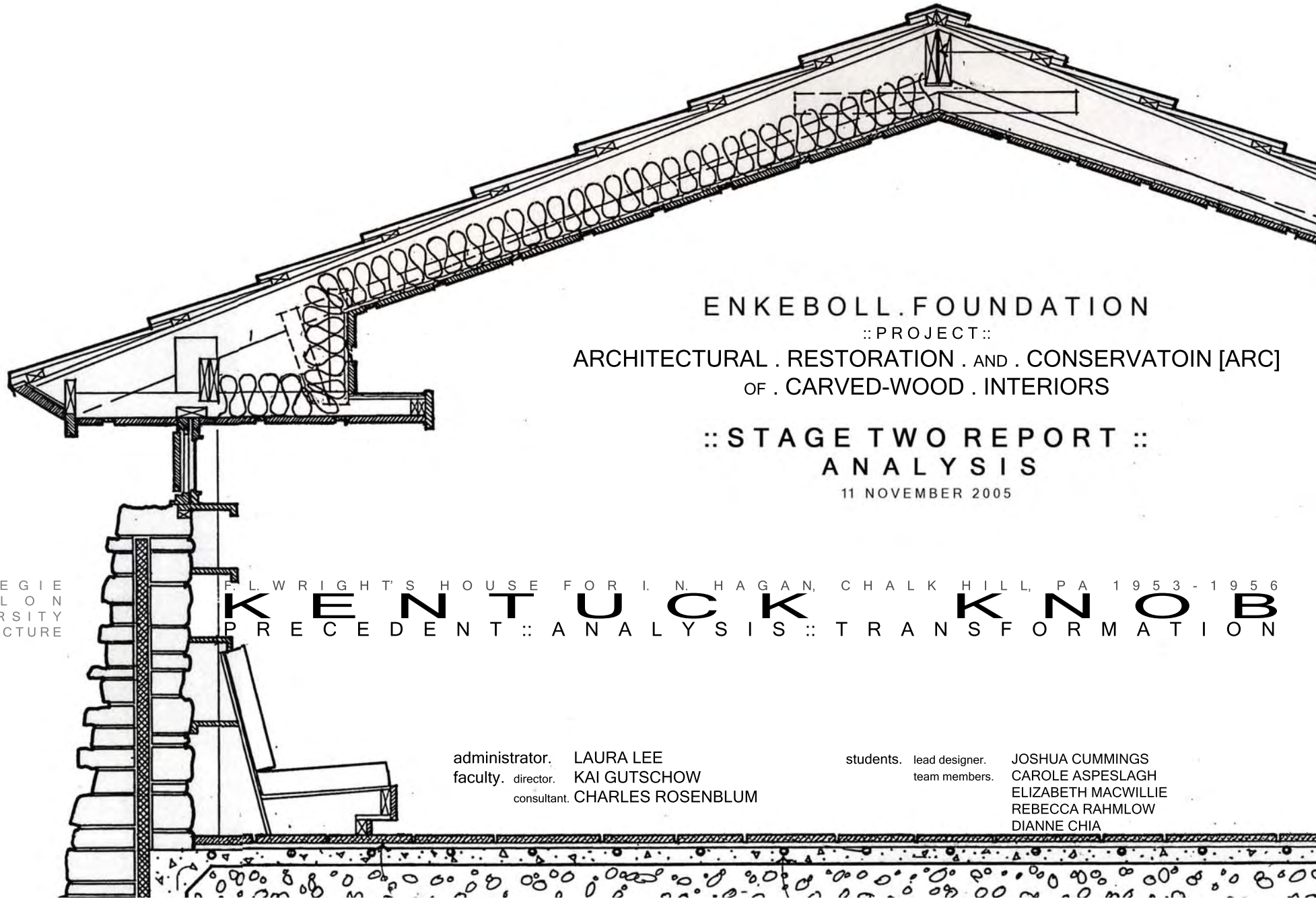

ENKEBOLL.FOUNDATION

::PROJECT::

ARCHITECTURAL . RESTORATION . AND . CONSERVATOIN [ARC]  
OF . CARVED-WOOD . INTERIORS

::STAGE TWO REPORT ::  
ANALYSIS

11 NOVEMBER 2005

CARNEGIE  
MELLON  
UNIVERSITY  
ARCHITECTURE

F. L. WRIGHT'S HOUSE FOR I. N. HAGAN, CHALK HILL, PA 1953 - 1956

**KENTUCK KNOB**  
PRECEDENT :: ANALYSIS :: TRANSFORMATION

administrator. LAURA LEE  
faculty. director. KAI GUTSCHOW  
consultant. CHARLES ROSENBLUM

students. lead designer. JOSHUA CUMMINGS  
team members. CAROLE ASPESLAGH  
ELIZABETH MACWILLIE  
REBECCA RAHMLOW  
DIANNE CHIA

## TABLE OF CONTENTS

### VOLUME I

#### Introduction

“Representation, Analysis, and Transformation: Kentuck Knob as Case Study”  
by Kai Gutschow

Outline of original Grant Proposal & Description

#### Stage I Report: Re-Presentation (Wright and Kentuck Knob)

“Culture and Context at a Wright Angle: Historical Background for Kentuck Knob”,  
by Charles Rosenblum

##### Appendices:

I: Kentuck Knob Bibliography

II: Kentuck Knob Chronology

III: Frank Lloyd Wright Chronology, 1930-1959

IV: Outline of Original Project

V: Research Notes, Stage I (Re-Presentation / Documentation)

VI: Course Materials, “Frank Lloyd Wright” #48-341, S’05, CMU

1) Course Description

2) Syllabus

3) Hagan House Analysis Assignments

4) Comparison Buildings for Kentuck Knob

5) Usonian House Handouts

VII: Hagan House Presentation, Stage I Meeting, Apr. 15, 2005

#### Stage II Report: Analysis (Kentuck Knob)

Chapter A: As-Built Drawings

Chapter B: Design Process & Working Drawings

Chapter C: Photo Galleries

Chapter D: Plan and ‘Unit System’ Analysis

Chapter E: Siting, Approach, and Promenade

Chapter F: Living Room Spatial Analysis

Chapter G: Cutout Windows

Chapter H: Furniture

Chapter J: Exterior: Ceiling, Trellis and Skylight

### VOLUME II

#### Stage III Report: Transformation (A Seating Opportunity for Kentuck Knob Estate)

Chapter 1: Introduction: Team, Teamwork, Technology

Chapter 2: Transformation: Preliminary Design Explorations

Chapter 3: Josh Cummings, 3<sup>rd</sup> Year Architecture Student

Chapter 4: Jared Langevin, 3<sup>rd</sup> Year Architecture Student

Chapter 5: Elizabeth Macwillie, 4<sup>th</sup> Year Architecture Student

Chapter 6: Chang Zhang, 3<sup>rd</sup> Year Architecture Student

Enkeboll Foundation  
for the Arts & Architecture

Sponsored Project:

**Architectural Restoration and Conservation (ARC)  
of Carved-Wood Interiors,  
2004-2005**

**Final Report  
Volume 1**

Carnegie Mellon University, School of Architecture

Administrator: Laura Lee  
Lead Faculty: Kai Gutschow

Date:  
11 November 2005

PROJECT:  
**Architectural Restoration and Conservation (ARC) of Carved-Wood Interiors  
2004-2005**

“Re-Presentation, Analysis, and Transformation:  
Kentuck Knob as Case Study”

by Kai Gutschow

Architecture is a complex and multi-faceted field that lies at the intersection of many seemingly divergent concerns related to how humans shape the environment around them. It is both art and engineering; embracing both craft and concepts; reliant on both traditions and innovation; dealing with both macro and micro scales. Architects, as well as architecture students, are constantly challenged to bridge between these concerns, making their discipline by definition inter-disciplinary. Their best work often comes when the challenges to be overcome are greatest.

In architectural education, as well as the profession more generally, history and innovative design often seem to conflict. At least since the Bauhaus, a profound understanding of history, traditions, and the past has often been seen as an impediment to advancing the frontiers of our discipline, to expanding our understanding of the contemporary world, and to real innovation using the tools we have at our disposal to confront the future.

Carnegie Mellon University’s team of students and supervising faculty have used the “Architectural Restoration and Conservation (ARC) of Carved Wood Interiors, 2004-2005” project funded by the Enkeboll Foundation for Arts and Architecture as an opportunity to investigate and overcome this divide. For the past year we have worked in a systematic way from a deep understanding of history to the most cutting-edge design. The vehicle for this research was Frank Lloyd Wright’s little-known, but amazingly innovative house designed and built for the ice-cream magnate I.N. Hagan in nearby Chalk Hill, Pennsylvania from 1953 to 1956. The house was a near-perfect fit for our research:

- Pittsburgh: It is relatively close to our hometown of Pittsburgh and ten minutes from its world-famous cousin, Wright's "Fallingwater." Through field-trips, and the uncovering of a rich array of local archival and published resources, we were able to study this building in incredible depth.

- Wood: The house, including the structure, wall and ceiling paneling, much built-in furniture, and free-standing furniture approved by Wright, was built primarily of wood, yet maintained an interesting dialogue with hidden structural steel and a massive stone plinth upon which the house rests.

- Integrated Design: As a "total work of art," that straddles the best craft traditions of the past with innovative features of the American post-war context, the house provided a text-book example of a "integrated design," one of the primary goals of CMU's architectural education. Wright's "organic" design knit together in a seamless system every aspect of the house, from solar-orientation and site planning, to spatial and structural design, to the intricacies of carved window cutouts and skylight dentils made of wood.

- Hexagon: The house is planned using one of Wright's characteristic "unit systems." With an innovative and uniquely flexible hexagonal geometrical system which we analogized to DNA, Wright "grew" a masterpiece of profound order, incredible intricacy, as well as freedom and openness to the beautiful, natural site.

- Modern: When seen in relation to partner studies of the Baroque Rubens House in Antwerp, and Thomas Jefferson's Neoclassical Monticello, Kentuck Knob offered a desirable historical, geographic, and conceptual progression into the modern age whose connections to the past could be documented. Built amidst the dynamic atmosphere that was post-war American culture, it sat on the brink between tradition and modernity. The house featured both the most innovative technology and household gadgets and yet must be seen as part of an increasingly rare specimen of an all-wood house designed by a cutting-edge designer.

- F.L. Wright: The once-again increasing popularity of Wright's architecture assured that the project would have a rich array of scholarly sources, would be at least somewhat familiar to a wide range of the public, and would not remain in historical obscurity: this was a house we could help elevate to the level of one of the icons of 20th-century architecture. The "genius" of Wright as a designer assured us of a case-study with literally limitless potential for learning and understanding to ever greater depths every nuance of the house.

- Sources: Within the spectrum of Wright studies, the house has been relatively little studied, and yet two focused monographs have come out within the last year

which we feel we can contribute to a better and deeper understanding of the house, the design, and the many contexts that generated them.

- Reproduction: Much of Wright's furniture and woodwork has already been reproduced, adding a level of realistic hopes that potential future designs based on this work would be relevant in contemporary society and find wide appeal.

- Innovative Design & Fabrication: Wright himself was famous for challenging the norms of architecture, both in design and in the use of technology during the construction, as well as for the operation of the buildings. On the other hand, his architecture is so distinctive and "stylized," that young architecture students are naturally inspired to move in their own directions rather than copying forms or ideas. Both of these led naturally to wanting to explore today's most advanced design, modelling, and fabrication tools. Here history seemed to inspire innovation.

- Teaching & Learning: All of the above, made the house a perfect case-study both for teaching undergraduate architecture students, and for students to explore with eagerness and constant amazement.

CMU's "ARC" investigation began in the Spring 2005 semester with a special "project course" that sought to bridge between history and design courses in our school. "Frank Lloyd Wright: Precedent, Analysis & Transformation," taught by Kai Gutschow, who has both a professional background in architectural design, and a doctorate in modern architectural history, was a rigorous architectural history course that sought to understand and learn from the design principles of F.L. Wright through a case-study method. After a survey introduction to the career and bibliography of F.L. Wright and investigations of several important houses from throughout his career, the class selected Kentuck Knob as the historical house to analyze and work with in detail for the rest of the semester. The group of 2<sup>nd</sup>, 3<sup>rd</sup>, 4<sup>th</sup>, and 5<sup>th</sup>-year architecture students moved from understanding and "re-presenting" the house, to "analyzing" both the house and the context that generated it, and finally explored a "transformation" of what they learned in the design of a completely new object, often related only very tangentially to the historical house. The constant theme of the course was to more fully understand a design of F.L. Wright's, especially the interior woodwork, much of which is carved in an abstract, modern manner, and see if it was possible to uncover "design principles" or "systems" that act like a "kit of parts." A concluding phase of the course investigated briefly how these principles might be used to generate or "grow" new designs through various transformations.

A second phase of the larger research project saw several students staying on as

a summer job to analyze in much greater depth, and through innovative analytical and communicative tools, the intricacies of Kentuck Knob's design. In order to maintain some parallel with a study by a partner team studying the Rubens House in Antwerp, Belgium, we decided to focus exclusively on the living room, one of the great interior spaces of modern architecture, and made primarily of cypress wood. We gathered all available resources, and using the innovative section through the main space as a way to focus, we investigated six specific architectural highlights that we felt were instrumental in creating the seminal experience of the house. Students were constantly challenged to look harder, to find interesting parallels in modern architecture, and to challenge the tried-and-true but often tired methods of architectural "analysis" that pervade tools they most architectural design studios. Through an intense, highly iterative process of seeing, modeling, presenting, and critique, the team created a model of architectural analysis that will soon be transferred into CMU's 2<sup>nd</sup>-year design curriculum. The results were presented in an array of over 120 11"x17" plates in the 2<sup>nd</sup> meeting of the Belgian and CMU research teams, where they elicited much discussion and encouragement to continue.

A final phase of the 2004-2005 ARC project took place during the first two months of the fall semester at CMU. A new batch of students joined a few students that stayed on from the spring and summer teams, to add new life and many new ideas to the process at the crucial moment when we turned from analysis to "transformation" and design. Each of the students was challenged to find diverse and interesting methods of building on the analysis of Kentuck Knob. Students brought many different levels of training, including a wide range of computer modeling and design tools they felt comfortable with, and a refreshing variety of knowledge and focused interests in specific aspects of the house. We worked at first without any restraints: there was no required site, no program, no scale, no aesthetic. The only requirements were that they create something that at least conceptually could be tied back to Kentuck Knob. After several iterations, the team came to increasing consensus about what they wanted to design: a "seating opportunity" for the rear-year of Kentuck Knob, though even that moved from the back terrace, to the "brow" of the hill just beyond. With often conflicting agendas, the students eventually agreed that although their designs could be innovative and appropriate in so many ways, we wanted to engage in the contemporary debates about computer aided design and rapid prototyping technologies that so many students, schools, and firms are creating revolutionary architectures. The project funding and original analysis assured a continuous focus on wood, and a relationship to Wright.

Maneuvering the diverse pressures of life as an architectural student, four students maintained the kind of sustained and creative intensity that led to the design of four very different though highly innovative approaches and designs for "seating opportunities." Two students decided to focus on the potential offered by a small laser-cutter that was made widely available to our team. Using Form-Z, Maya, AutoCad, as well as hand sketching these students were led to designs that featured an intricate array of parallel planes, as only a laser cutter could create. This Enkeboll-funded project was instrumental in getting CMU undergraduate architecture students access to a small laser cutter, releasing pent-up demand, and feeding hopes and ambitions for more, bigger, and more advanced machines. Two other students were intrigued by the more dynamic spatial complexities that Maya software is able to help architects realize. The resulting forms offered completely new ways of understanding the potential of some of Wright's design ideas, particularly his use of the "Hagan Hexagon." These designs went challenged and eventually went far beyond the rapid prototyping resources available to CMU students. A milling machine, a 3-D scanner, and other technologies might in the future offer the students to create models of their complex forms, and ideally life-sized constructions.

The students and faculty are eager to continue the explorations of the past year. After absorbing the lessons of the different designs, the plan is to come to a consensus and use team-work to design a single object in much greater detail, placing into greater focus the complexities introduced into any design when confronting the unique properties of wood, when inventing new means of connections and joinery, when introducing issues such as cost, available manufacturing technologies, ergonomics, location, and weather. The team expects to use the spring 2006 semester to design and build a life-sized "seating opportunity" and bring it to the attention of the owner of Kentuck Knob, the famous art patron and connoisseur Lord Peter Palumbo, in the hope that he might let students place their innovative design on the site, in the context of the famous historical house. Eventually, more focused research, re-presentation, analysis, and transformative design will lead to the publication of journal articles in the architectural and educational press, to a museum exhibit and catalogue, and to books that could inspire architects and the profession to look to history one of the means of innovating.

This report should serve as a document and proof of both the thorough and innovative work achieved by the CMU students on all three phases of the ARC project--representation, analysis and transformation--, as well as promise that even richer work would develop with additional time and technological resources.

PROJECT:  
**Architectural Restoration and Conservation (ARC) of Carved-Wood Interiors  
2004-2005**

- GOALS: To increase the awareness and understanding of carved wood.
- To publish existing applications leading to new solutions of carved-wood elements
  - To develop guidelines and techniques for the restoration, conservation and duplication of carved wood elements and interiors
  - To inspire the creation of innovative wood-carved elements and interiors based on traditional methods, automated manufacturing, and/or state-of-the-art digital technologies
  - To develop a research strategy that insures both in-depth analysis as well as broad understanding of wood-carving by integrating a case-study method with collaborative and comparative research by an international group of research teams.

PROJECT OVERVIEW:

The project begins by reviewing existing Enkeboll elements and product lines, in order to focus and guide the selection of three cases, known as “period residences” in the region of each participant. Cases will be selected according to various criteria, including proximity and access to research materials for each participant, and the desire to span broad historical as well as regional variations to insure rich comparative work. The wood-work in each case is to be both exemplary of the historical context in which it was created, and full of potential for contemporary investigation and possible future production. The particular case selected by each participant will reflect the specific nature of the research investigation, from “Restoration and Conservation” as well as “Duplication” of existing carved-wood elements using new techniques and automated technologies, to the “Manipulation” of existing patterns in order to create new carved-wood elements and systems.

A three-step research and creation process will guide each participant team in a similar manner from a text-based “Re-Presentation” of the case, to image-based “Documentation and Analysis,” to object-based “Production.” Stage I will involve the “Re-Presentation” of the history of each case based on a common case-study template for all three residences, moving from the general historical

context of the building to the detailed description of all the building’s elements, especially the carved wood-work. Stage 2 will document and analyze each case primarily through images, including measured drawings, photographs, and analytical drawings that will address issues of formal typology, design intentions, production methods, as well as the meaning and experience of the building elements and woodwork. The research results of each participant begin to diverge according to the particular research focus mentioned above. However, the emphasis for all participants will remain both documenting the existing wood work and expanding our understanding of the historical work through innovative analysis that will lead to creative production. Based on the results of this work, a Stage 3 could pursue the development of new techniques and technologies for new carved wood elements and product lines by the Enkeboll Corporation.

RESEARCH FOCI:

- Restoration and Conservation of Existing Wood Elements based on Traditional Methods, using New Techniques (Antwerp)
- Duplication of Existing Elements Using Automated (Rapid Prototyping) Systems (NCSU)
- Transformation of existing patterns and Creation of New Carved-wood Elements and Systems (CMU)

RESEARCH PROCESS

- Stage 1: Re-Presentation (text): Selecting and Writing Case Studies
- Stage 2: Documentation and Analysis (image): Inventory of Wood Parts, Preparation of Measured Drawings, and Innovative Analysis and Comparison to insure Greater Understanding of each Element and its Role in the Overall Design
- Stage 3: Production (object): Proposal for New Techniques, Elements and Product Lines for Enkeboll

HYPOTHESIS

By thoroughly documenting, creatively analyzing, and selectively comparing wood-work from a three very different eras and three very different regions, we can gain both a deeper understanding of the particular, exemplary nature of each historical case study, and a broader, more creative sense of how this case study can inform contemporary practice and production.

**AS BUILT DRAWINGS [A]**

- A1 AREA TOPO AND PHOTO
- A2 AS-BUILT SITE PLAN
- A3 AS-BUILT PLAN
- A4 REFLECTED CEILING PLAN
- A5 ROOF PLAN
- A6 FRAMING PLAN
- A7 RADIANT HEATING PLAN
- A8 COURTYARD ELEVATIONS
- A9 GARDEN ELEVATIONS
- A10 MAGNIFIED PLAN
- A11 WINDOW DETAIL
- A12 BUILT-IN SEAT/SHELVES ELEVATION/PLAN
- A13 LIVING ROOM SECTION
- A14 PLANTER/HEARTH SECTION
- A15 DINING AREA SKYLIGHT SECTION
- A16 DENTIL AND LIGHT DETAIL
- A17 KITCHEN SECTION
- A18 KITCHEN SKYLIGHT FRAME DETAIL
- A19 KITCHEN AND DINING PLAN
- A20 KITCHEN CABINERY DETAILS
- A21 MASTER BEDROOM SECTION
- A22 MASTER BEDROOM SECTION 2
- A23 EAVE DETAIL SECTION
- A24 MASTER BEDROOM PLAN
- A25 BEDROOM CASEWORK

**DESIGN PROCESS AND WORKING DRAWINGS [B]**

- B1 INITIAL PERSPECTIVES
- B2 INITIAL PERSPECTIVES 2
- B3 INITIAL PLANS
- B4 SITE PLAN
- B5 MECHANICAL PLAN
- B6 PLAN
- B7 FRAMING PLAN
- B8 ELEVATIONS
- B9 SECTIONS
- B10 MILLWORK
- B11 (CABINET DETAILS)

**PHOTO GALLERIES [C]**

- C1 EXTERIORS
- C2 LIVING ROOM TO PROW
- C3 HEARTH AND DINING ROOM
- C4 KITCHEN . HALL . BEDROOM

**PLAN AND UNIT SYSTEM ANALYSIS [D]**

- D1 UNIT GEOMETRIES ANALYSIS
- D2 KENTUCK KNOB GRID ANALYSIS
- D3 REGULAR PLAN GEOMETRY ANALYSIS
- D4 REGULAR PLAN GEOMETRY ANALYSIS 2
- D5 IRREGULAR PLAN GEOMETRIES
- D6 GRID POTENTIAL
- D7 30-60 PRECEDENT ANALYSIS
- D8 DISSOLVING PLAN ANALYSIS
- D9 HEXAGONAL PLAN ANALYSIS
- D10 PARALLELOGRAM PLAN ANALYSIS
- D11 TRIANGLE PLAN ANALYSIS
- D12 PLAN GRID LIST
- D13 STUDENT ANALYSIS/DESIGN

**SITING, APPROACH, AND PROMENADE [E]**

- E1 SITE ORIENTATION ANALYSIS E2
- E2 HILLSIDE PHOTOGRAPHS
- E3 ENTRANCE PATHS
- E4 COMPRESSION AND RELEASE ANALYSIS
- E5 VIEW FRAMING

**LIVING ROOM SPATIAL ANALYSIS [F]**

- F1 WRIGHT LIVING ROOMS
- F2 KENTUCK KNOB SECTION ANALYSIS
- F3 SPATIAL ZONES ANALYSIS 1
- F4 SPATIAL ZONES ANALYSIS 2
- F5 SEAT - VIEW ANALYSIS
- F6 SEAT - VIEW ANALYSIS
- F7 CEILING ANALYSIS
- F8 HEXAGONAL FURNITURE
- F9 WOODEN CEILINGS
- F10 WOODEN CEILINGS 2
- F11 LIGHT ORNAMENT
- F12 LIGHT ORNAMENT 2
- F13 MATERIAL SELECTION
- F14 STEEL STRUCTURE
- F15 STEEL STRUCTURE TWO
- F16 WINDOW WALLS
- F17 WINDOW WALLS TWO
- F18 INTERIOR - EXTERIOR RELATIONSHIP
- F19 INTERIOR - EXTERIOR RELATIONSHIP TWO

**CUTOUT WINDOWS [G]**

- G1 CUTOUT GEOMETRY ANALYSIS
- G2 CUTOUT COMPARISON
- G3 CLERESTORY ARRANGEMENTS
- G4 POPE-LEIGHEY COMPARISON
- G5 AULDBRASS COMPARISON
- G6 SAMARA COMPARISON
- G7 CUTOUT WINDOWS
- G8 CUTOUT WINDOWS TWO
- G9 CUTOUT WINDOWS THREE
- G10 NATURE AND GEOMETRY
- G11 NATURE AND GEOMETRY TWO
- G12 FROEBEL GEOMETRIES
- G13 LOUIS SULLIVAN
- G14 EXOTIC INFLUENCES
- G15 JAPAN
- G16 MODERN ART
- G17 SCREENS

**FURNITURE [H]**

- H1 LIVING ROOM FURNITURE
- H2 BUILT-IN FURNITURE
- H3 BUILT-IN SEAT COMPARISON
- H4 HEXAGONAL ROOMS
- H5 COMPARISON DETAILS
- H6 COMPARISON DETAILS TWO
- H7 OTHER DESIGNERS
- H8 OTHER DESIGNERS TWO
- H9 OTHER DESIGNERS THREE
- H10 HEXAGONAL FURNITURE
- H11 HEXAGONAL FURNITURE

**EXTERIOR OVERHAND AND TRELLIS [J]**

- J1 HAGAN TRELLIS GEOMETRY ANALYSIS
- J2 SUN PATH ANALYSIS
- J3 OVERHANG PLAN GEOMETRY ANALYSIS
- J4 PERGOLAS DETAIL
- J5 WRIGHT: TELLIS AND CUTOUTS
- J6 MODERNIST EXAMPLE
- J7 MODERNIST: TRELLIS AND CUTOUTS
- J8 MODERNIST: EAVE DETAILS
- J9 SKYLIGHT SECTIONAL GEOMETRY
- J10 WRIGHT DENTILS



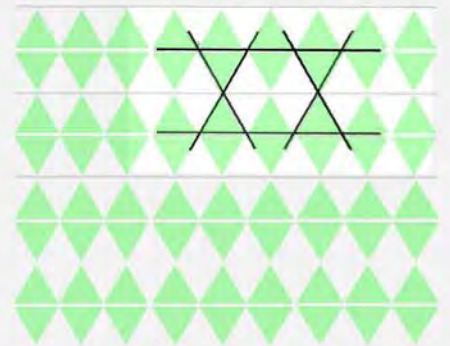
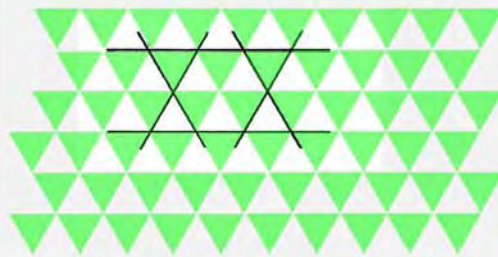
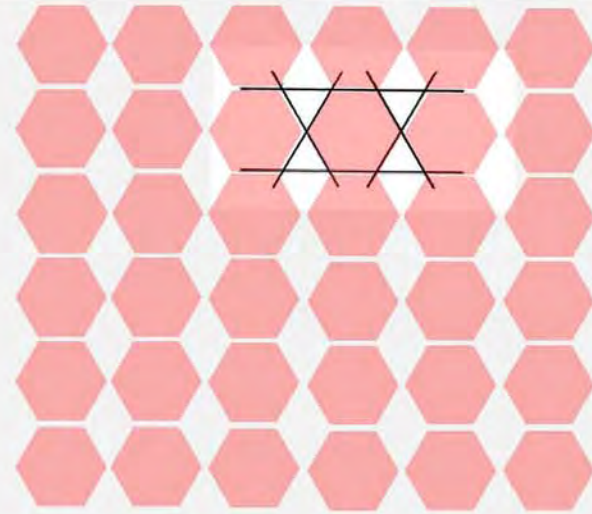
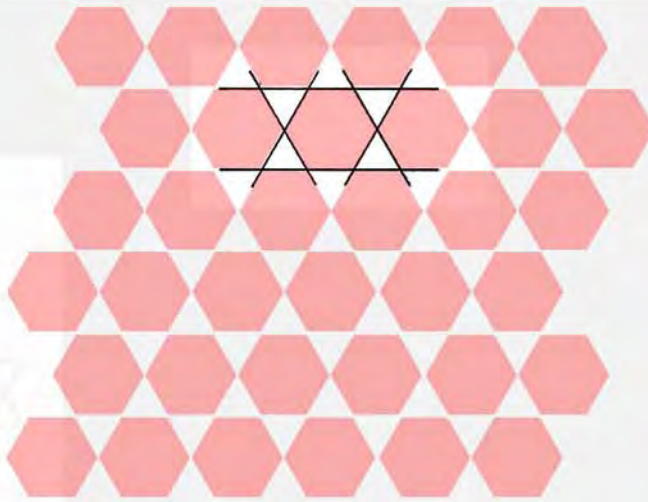
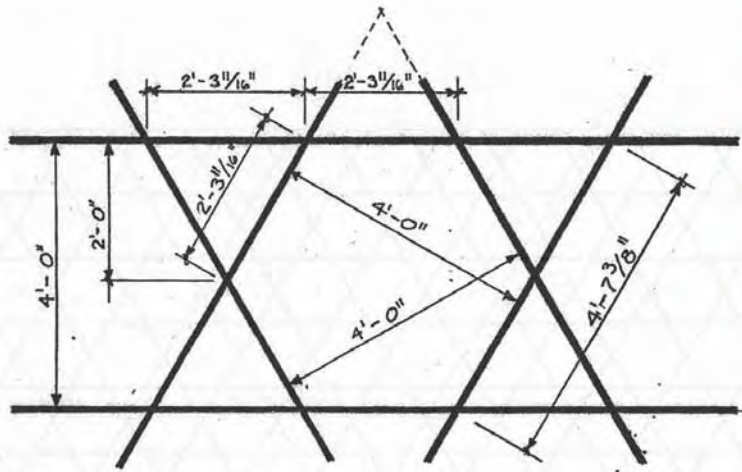

UNIT SYSTEM

1/2" = 1'-0"

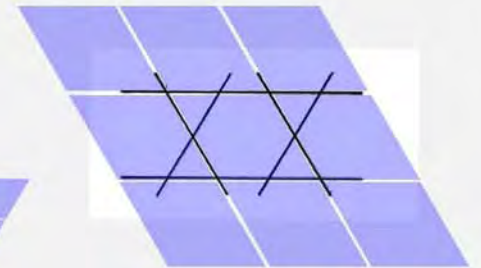
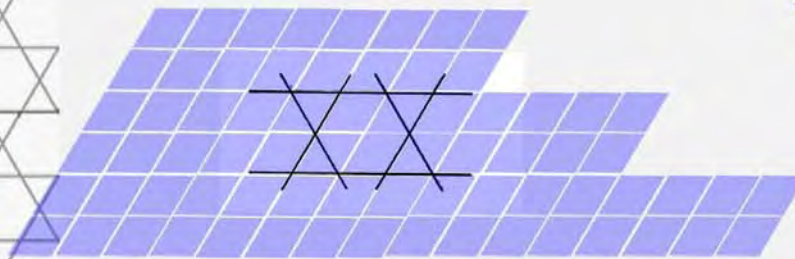
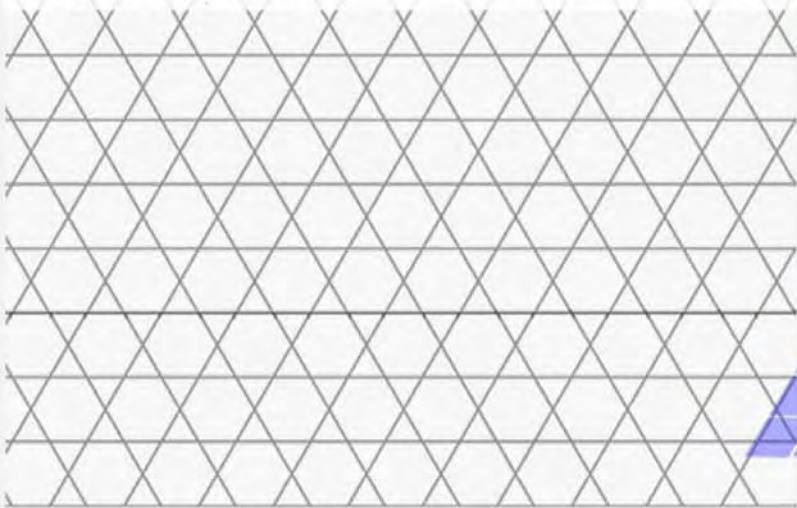

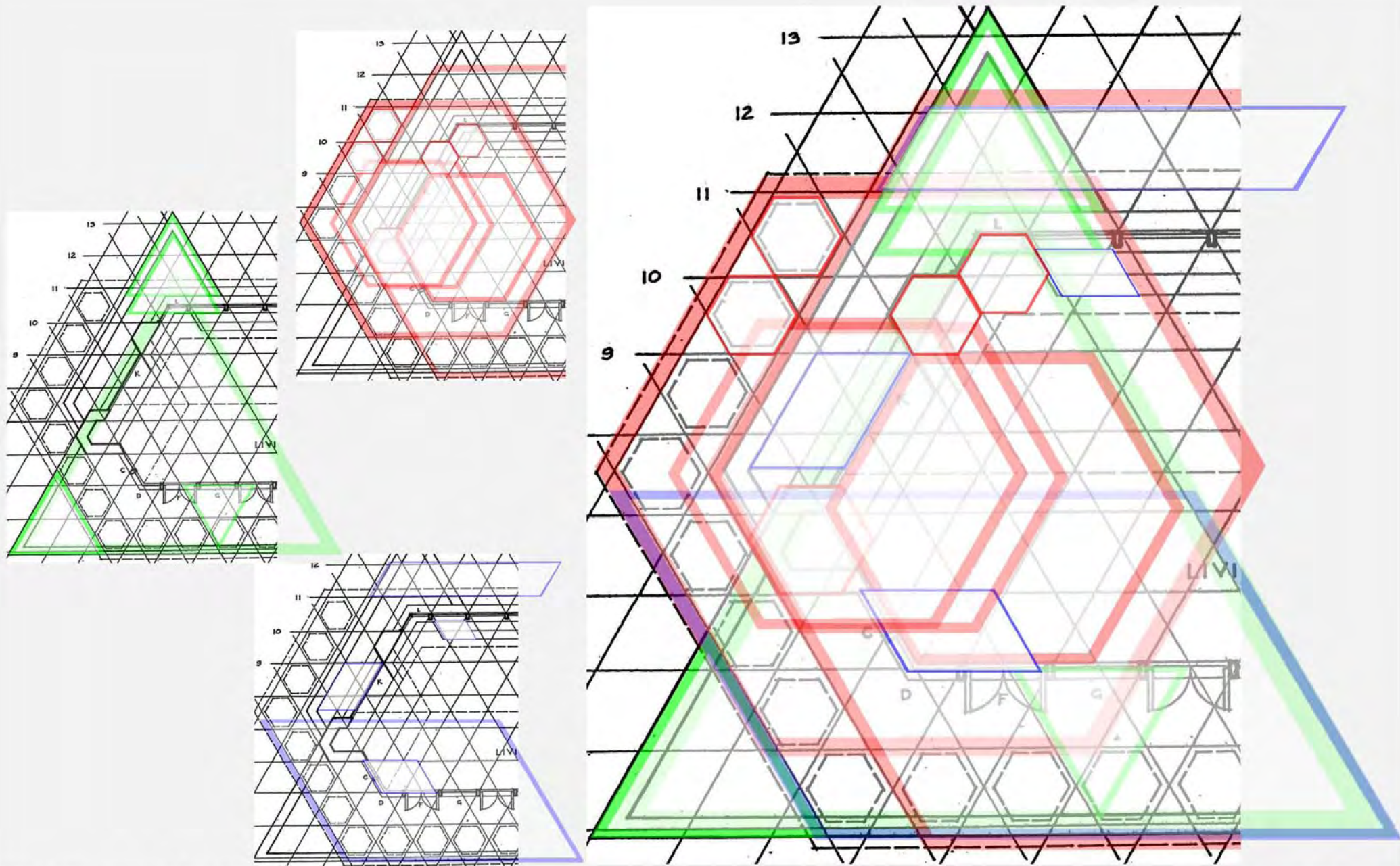

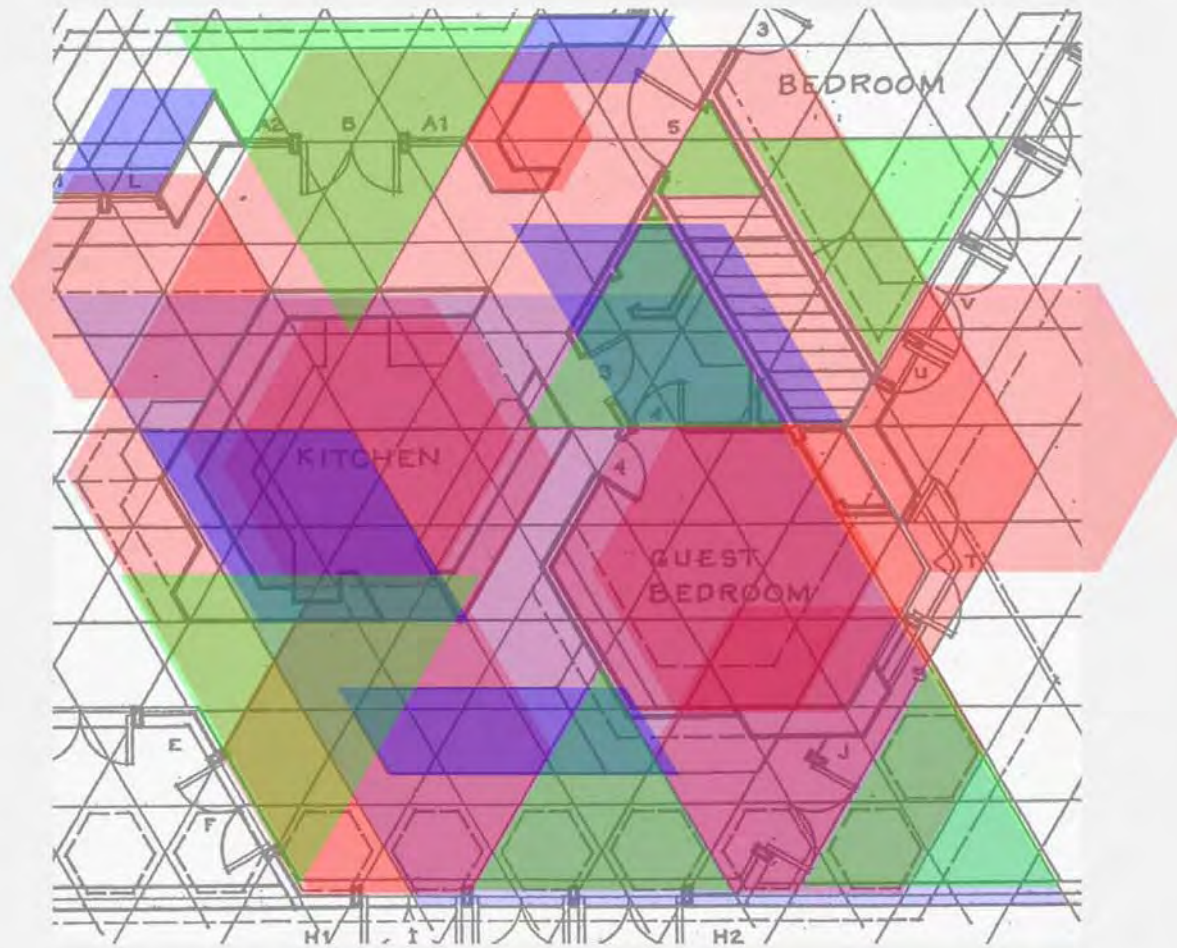
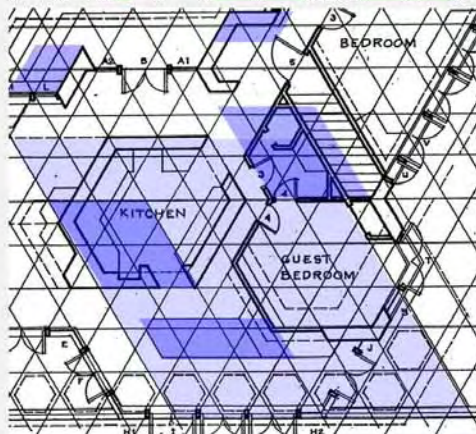
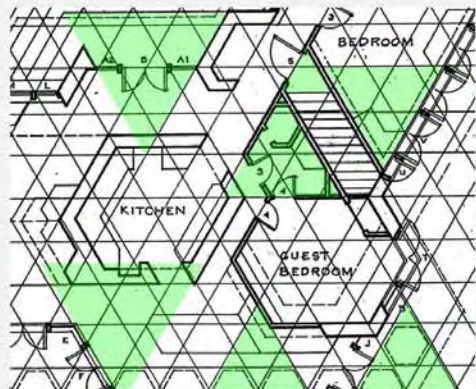
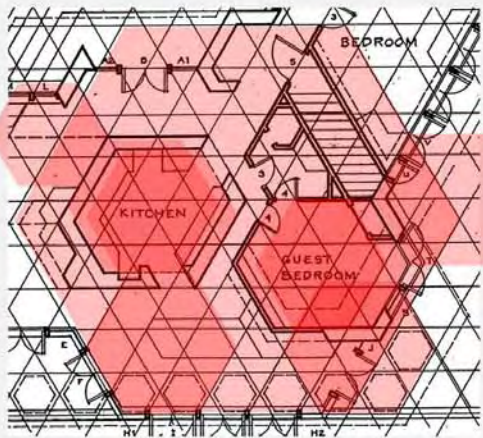

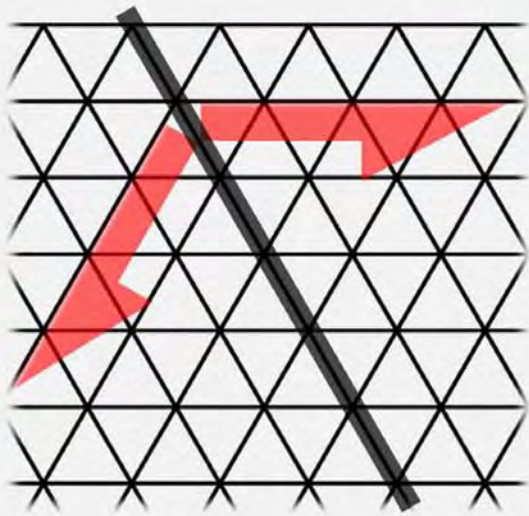

STANDARD TRIANGLE GRID

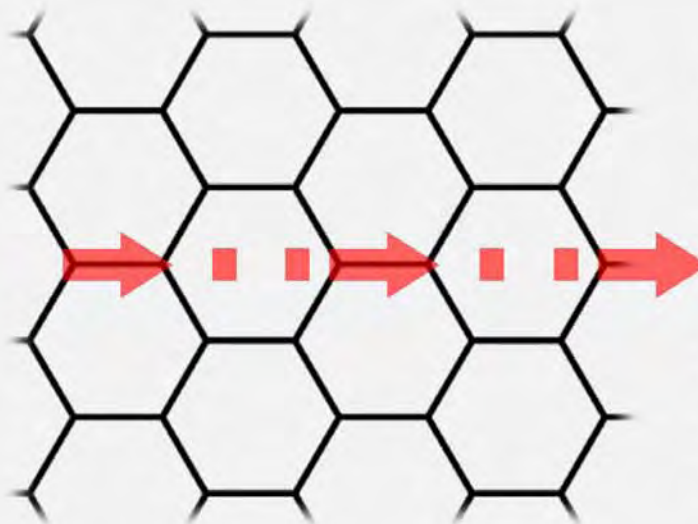

STANDARD HEXAGON GRID

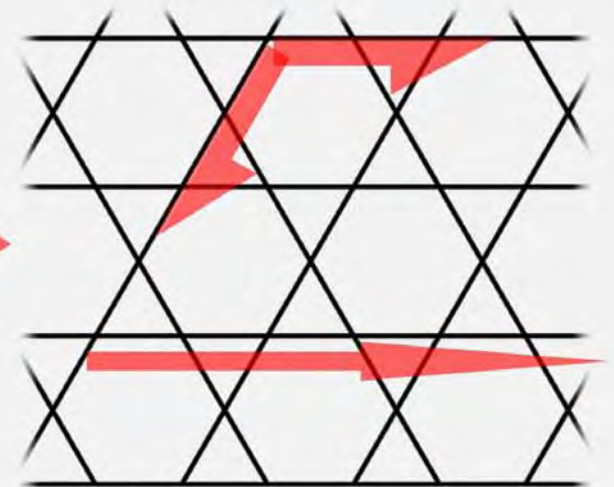

HAGAN "STAR" GRID

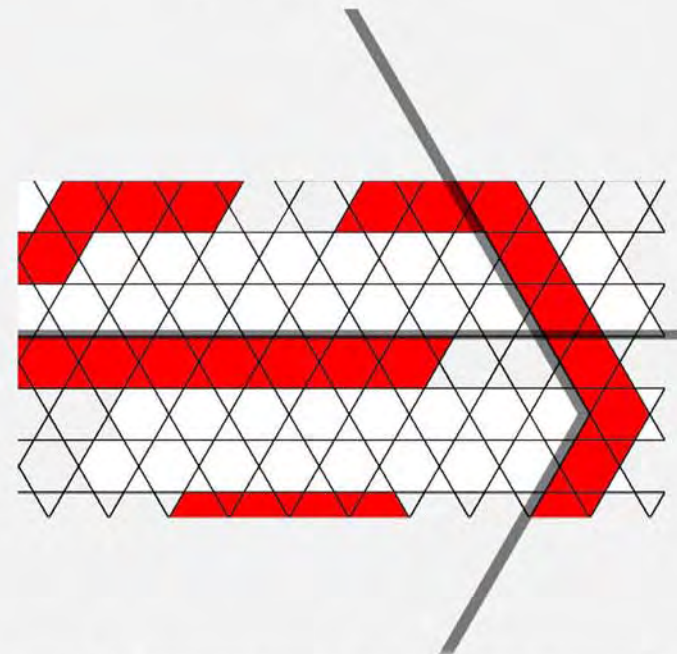
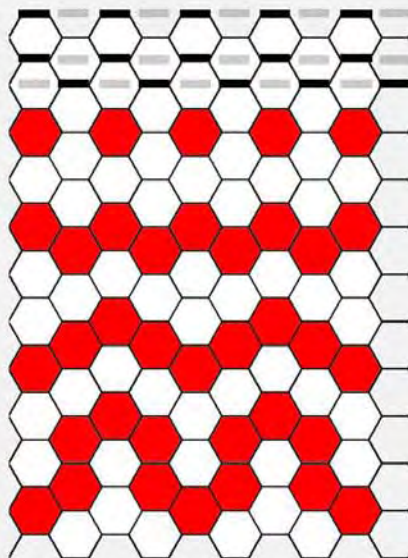
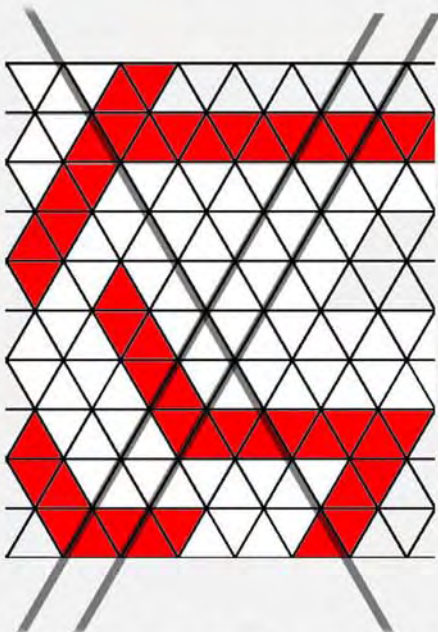

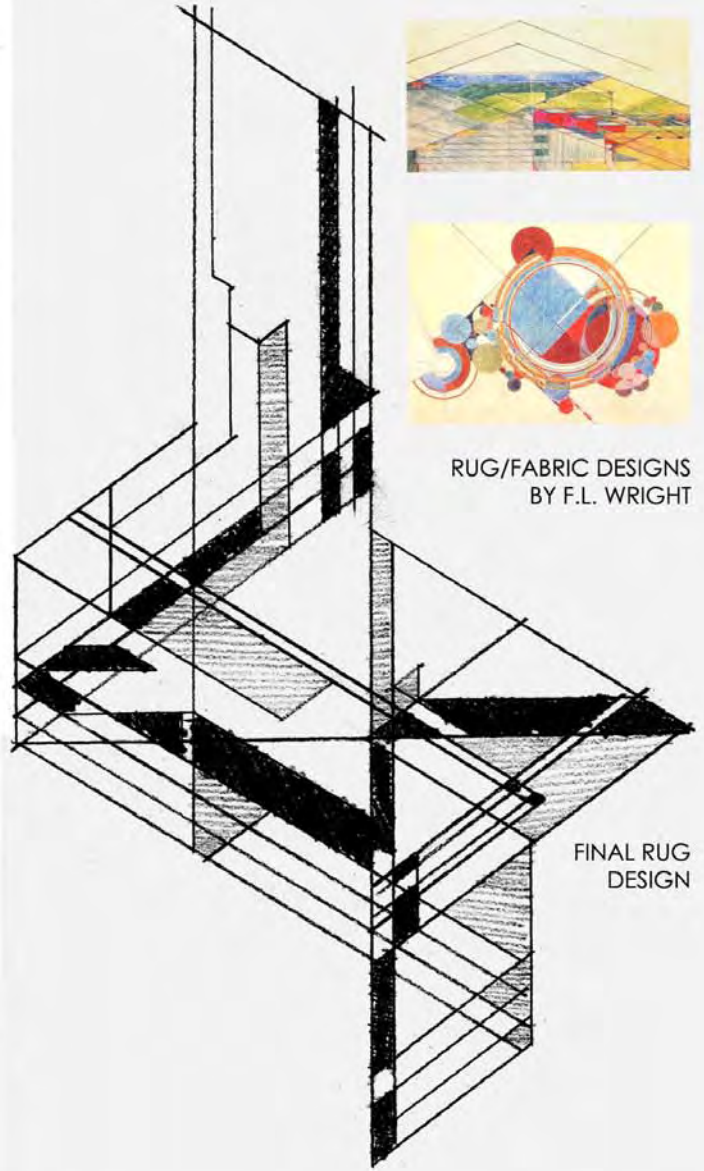
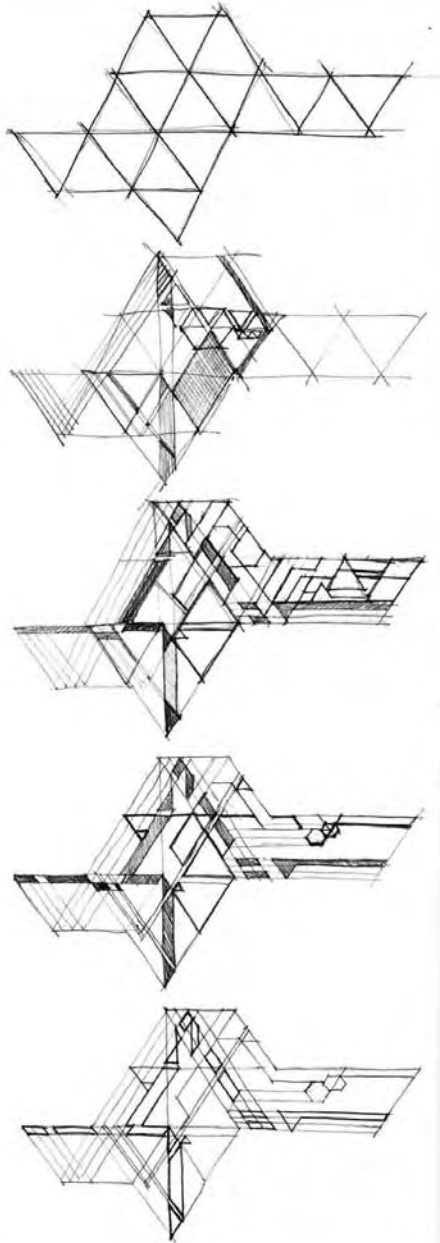
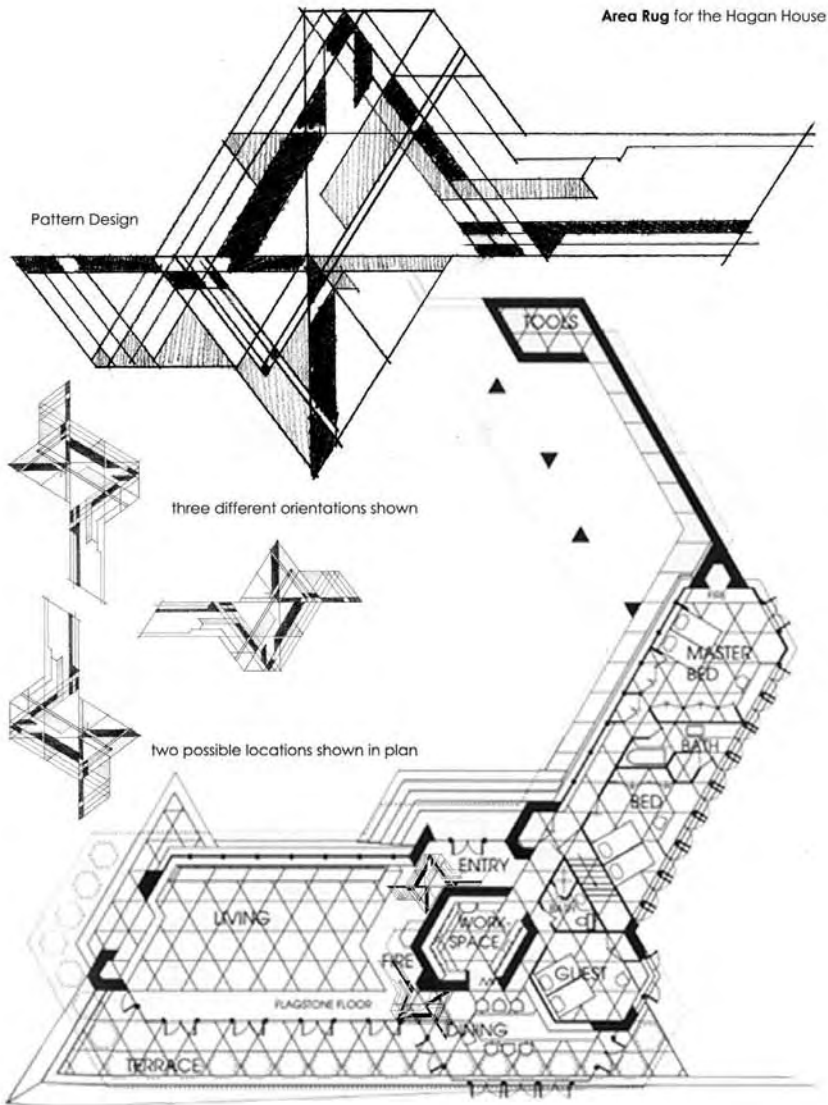

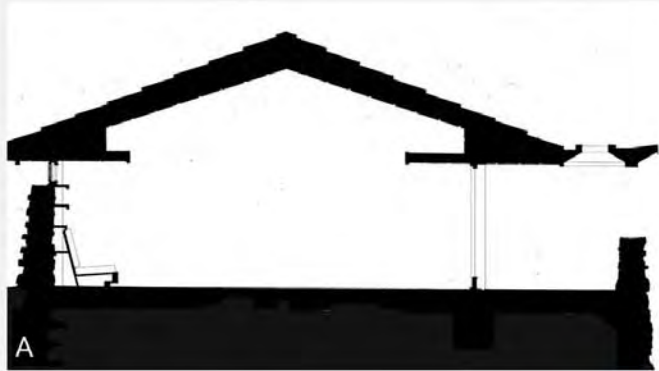

A

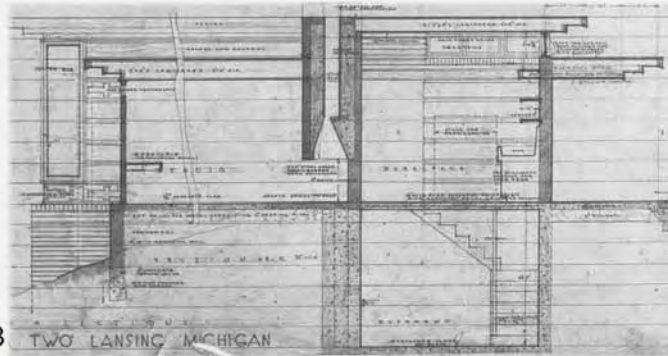

B

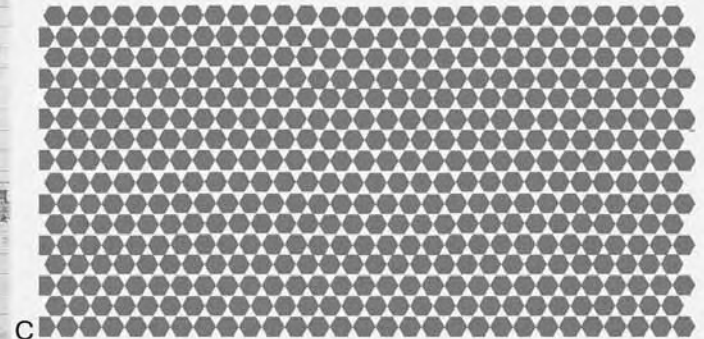

C

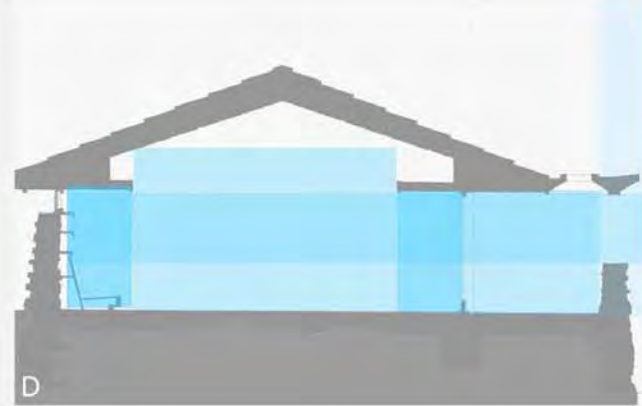

D

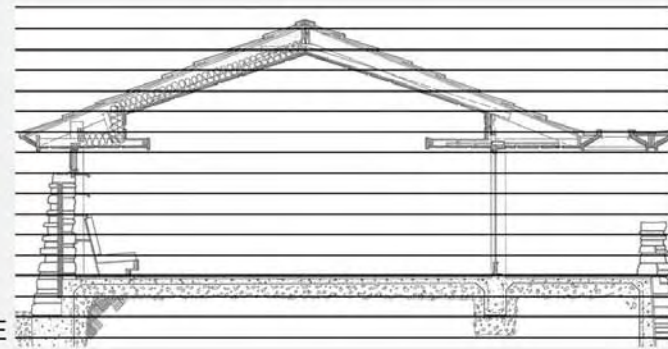

E

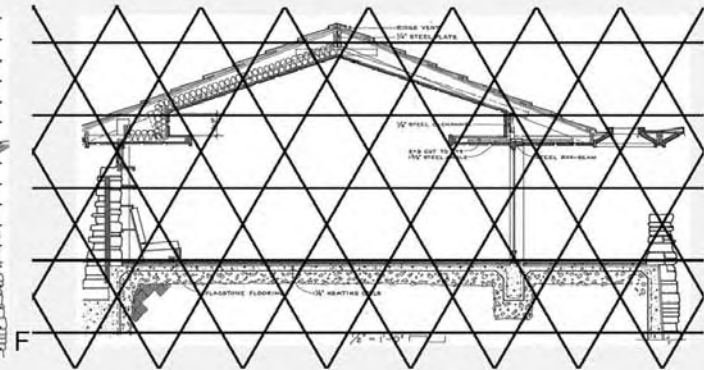

F

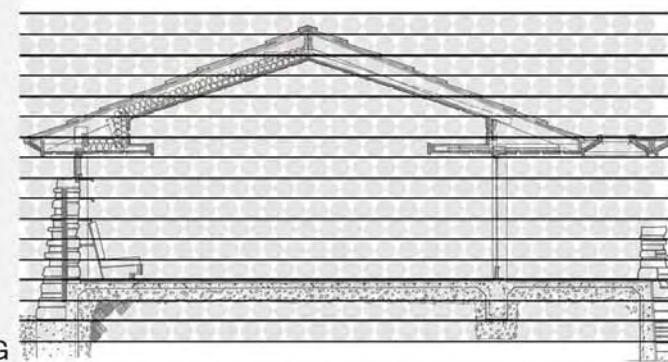

G

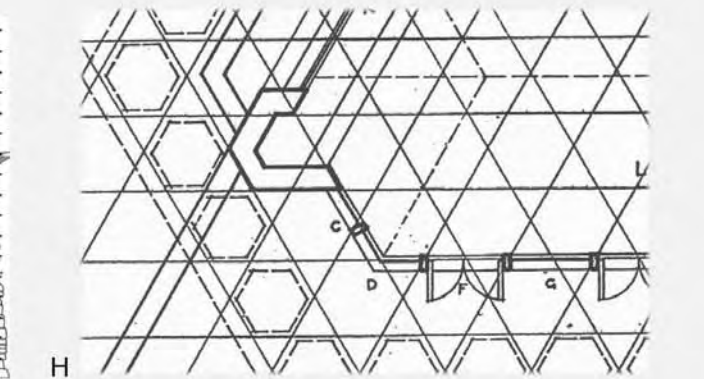

H

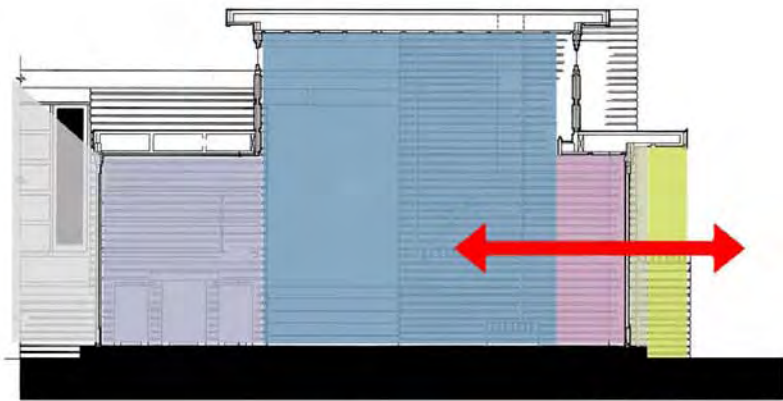

A

POPE-LEIGHY . 1939

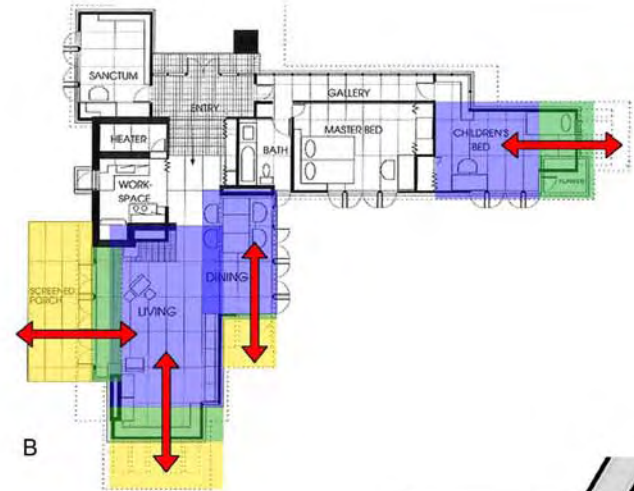

B

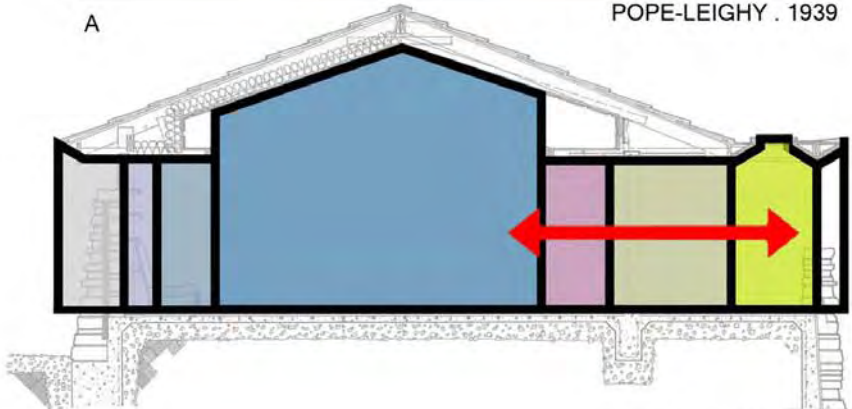

C

KENTUCK KNOB

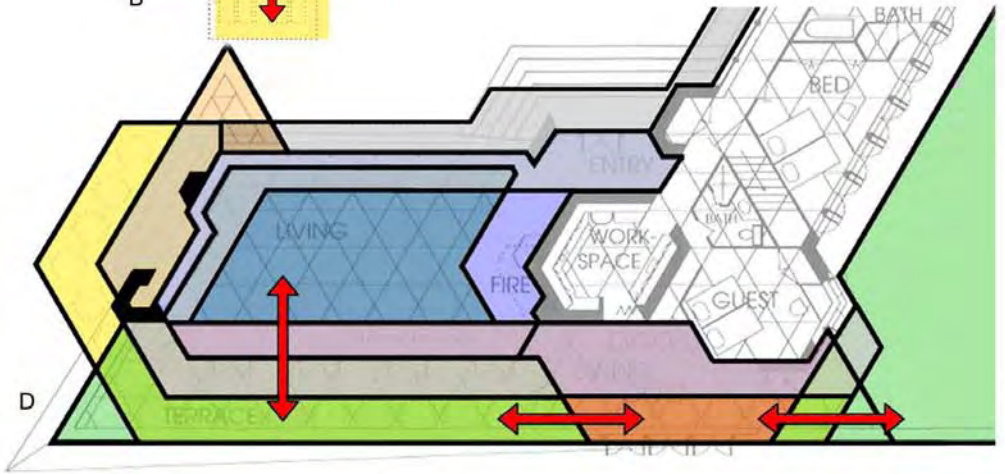

D

LACEAU ANALYSIS



E

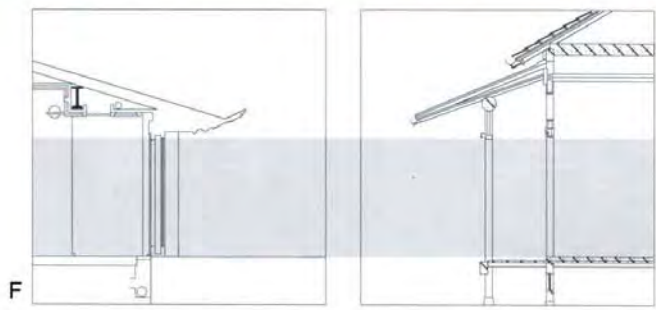

F

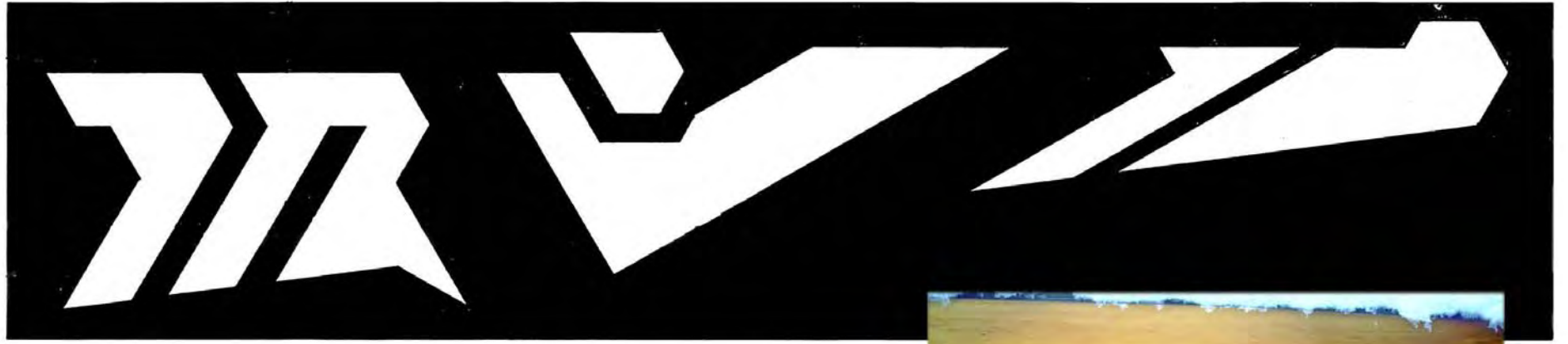

LIGHT / DARK BALANCE

GEOMETRIC RHYTHM

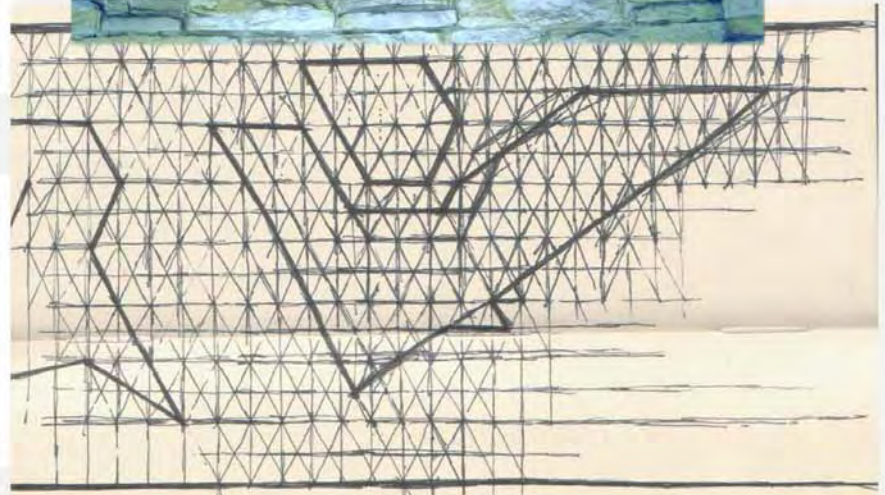
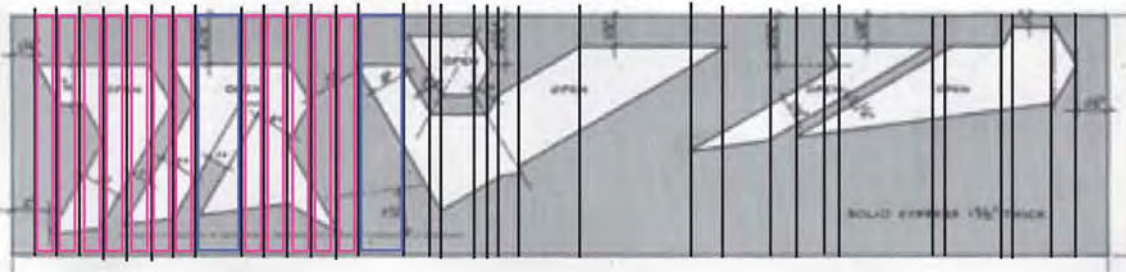





A

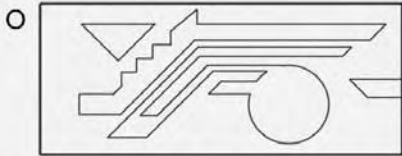

O

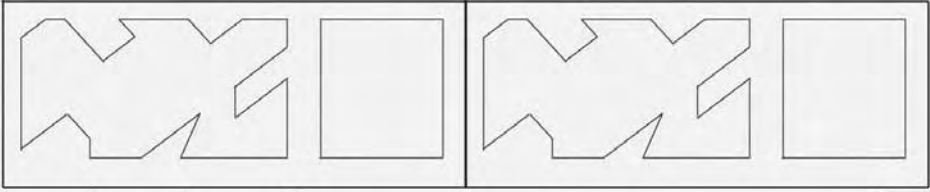

N

P

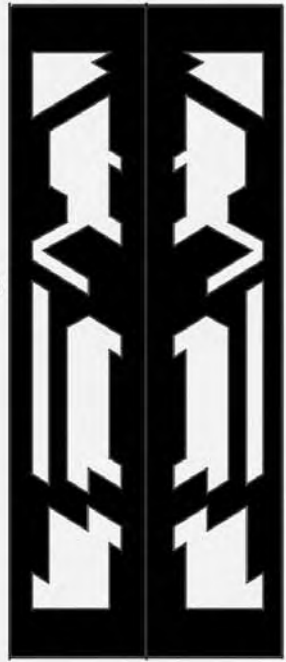

B

- A: KENTUCK KNOB
- B: POPE-LEIGHY . 1939
- C: KUNDERT MEDICAL CLINIC . 1955
- D: WELTZHEIMER RESIDENCE . 1948
- E: FAWCETT RESIDENCE . 1955
- F: BERNARD SCHWARTZ HOUSE . 1939
- G: AULDBRASS . 1939
- J: M.M.SMITH . 1946
- K: GUGGENHEIM USONIAN . 1953
- L: SAMARA . 1954
- M: M.M.SMITH . 1939
- N: BAZETT HOUSE . 1939
- O: DUEY WRIGHT HOUSE . 1956

NOT PICTURED: ABLIN . CARR .  
COMMUNITY CHURCH KANSAS CITY .  
GILLAN . LEVIN . MCCARTNEY .  
ROSENBAUM . STROMQUIST



C

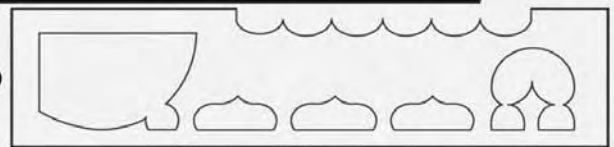

D



E

F

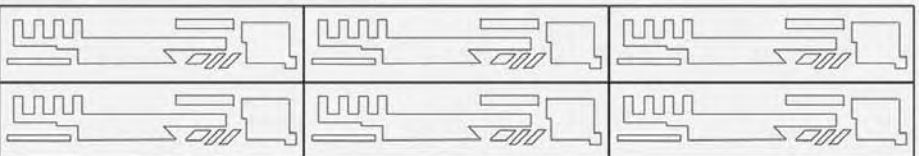
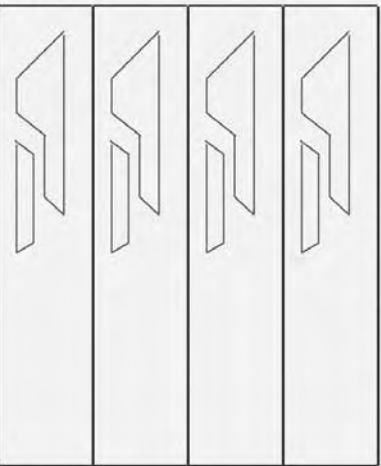

G

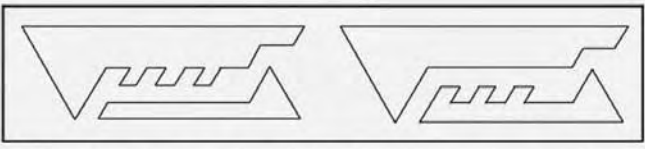

H

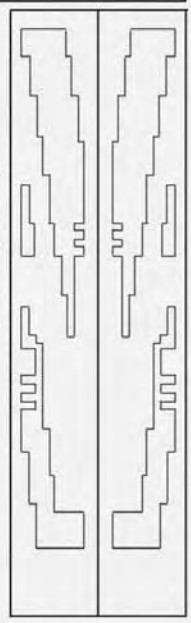

J



L

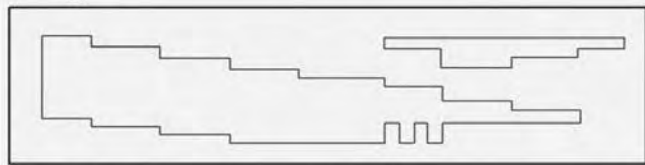

M

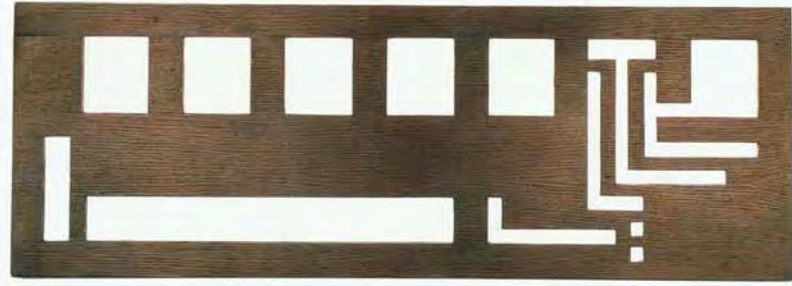

K

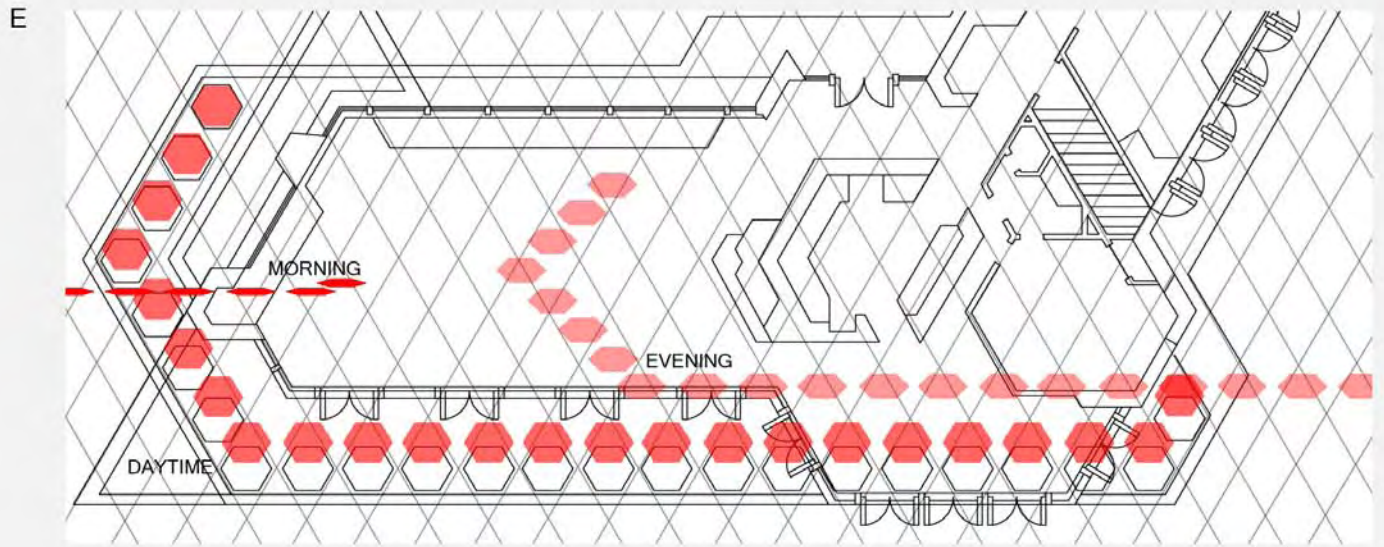
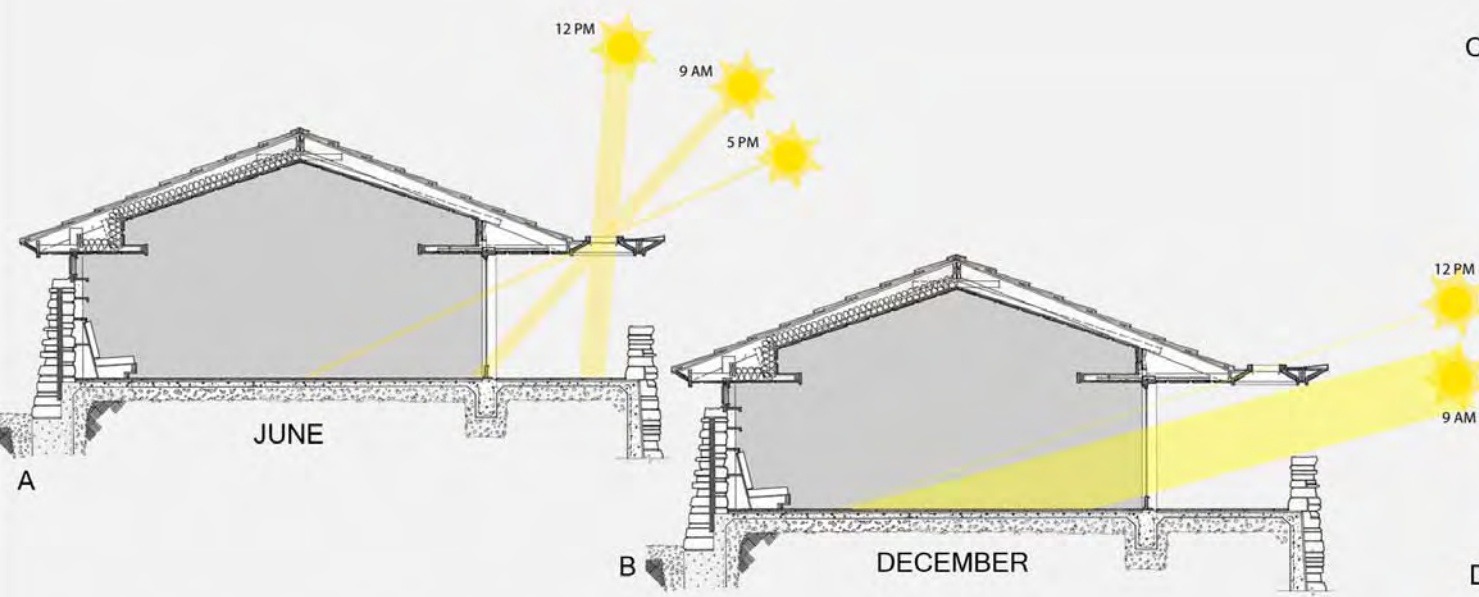

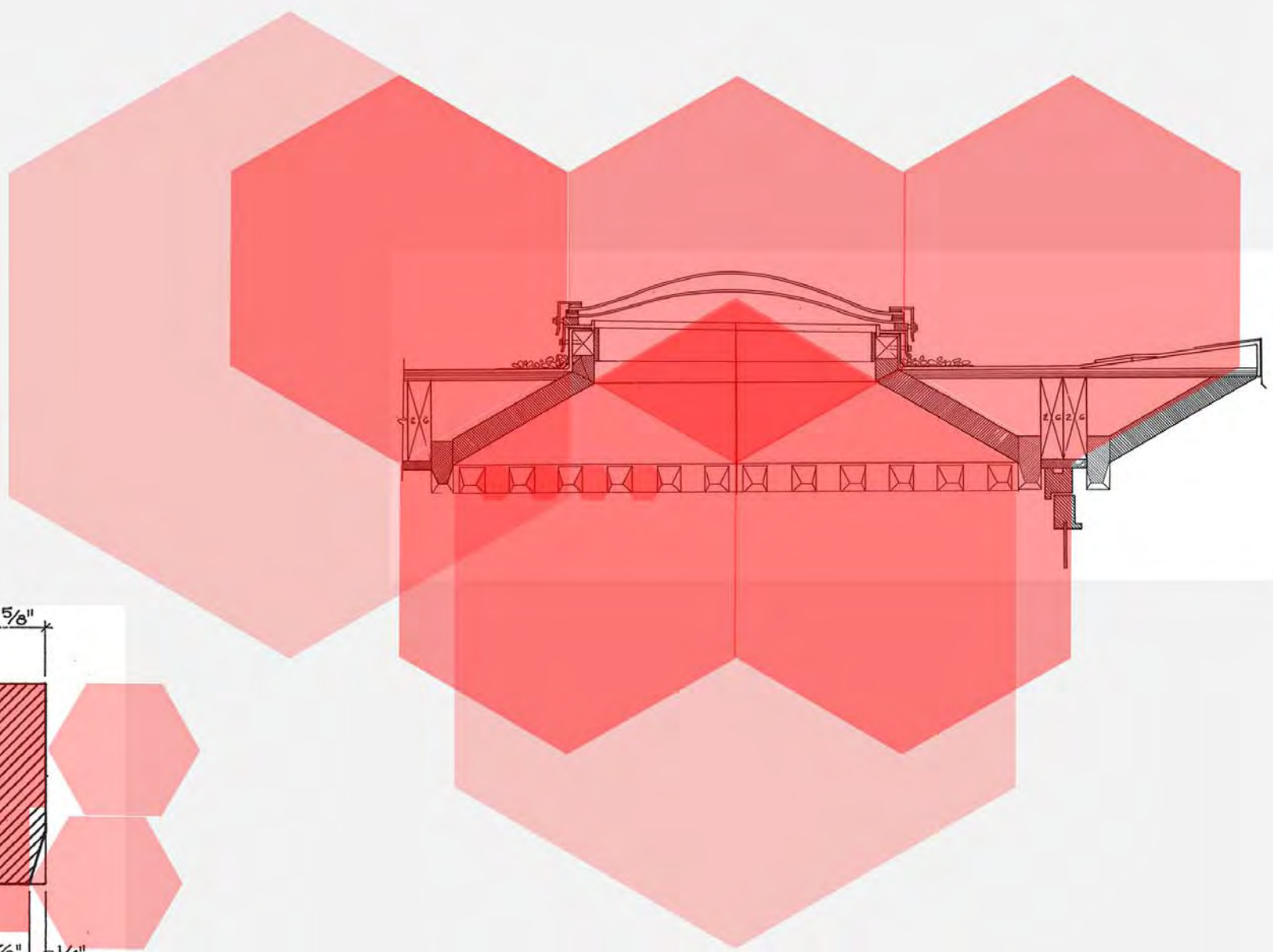
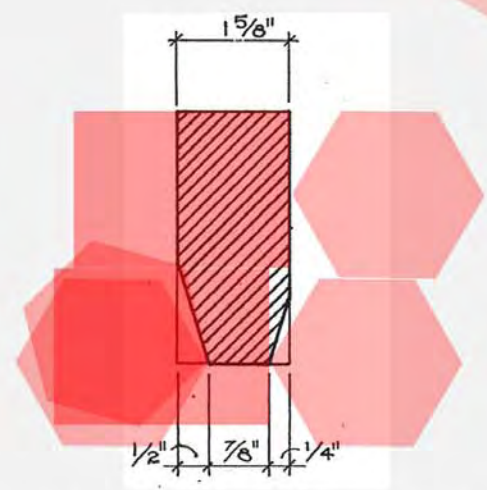
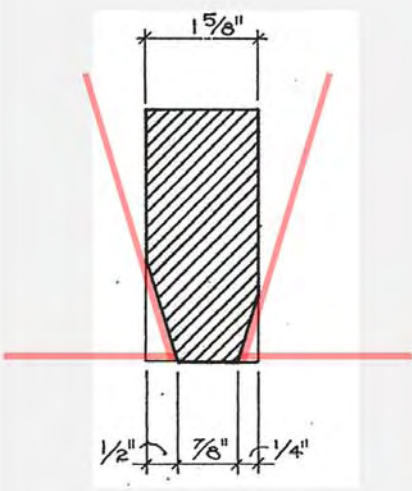

Hagan House  
Research Project:  
Stage III  
transformation

*School of Architecture  
Carnegie Mellon University*

November 2005

[full text]

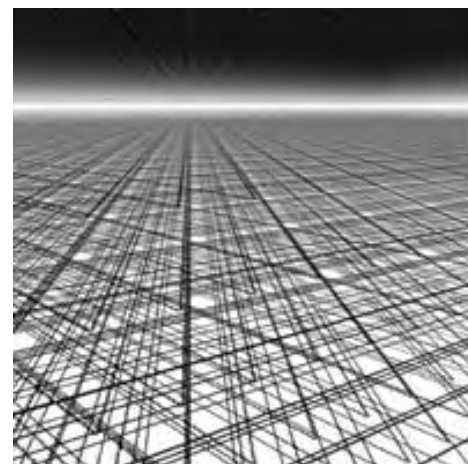
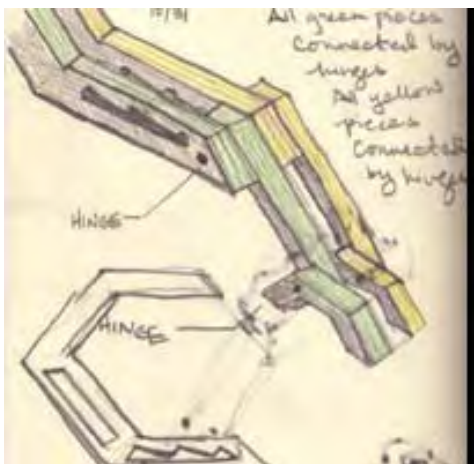
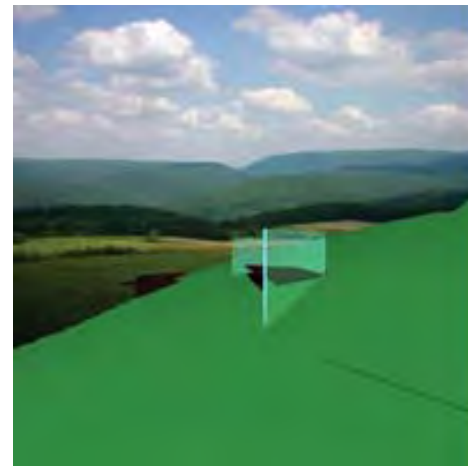
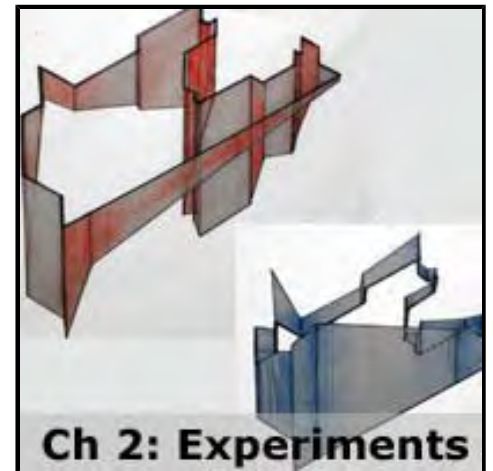
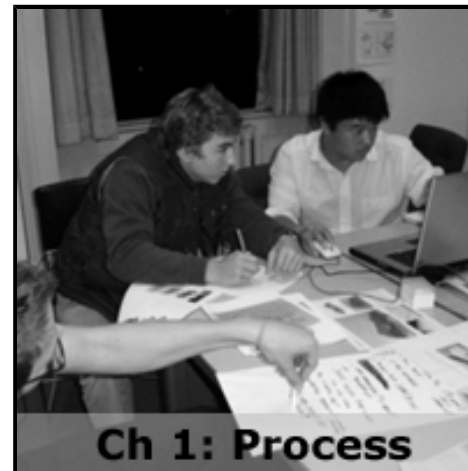

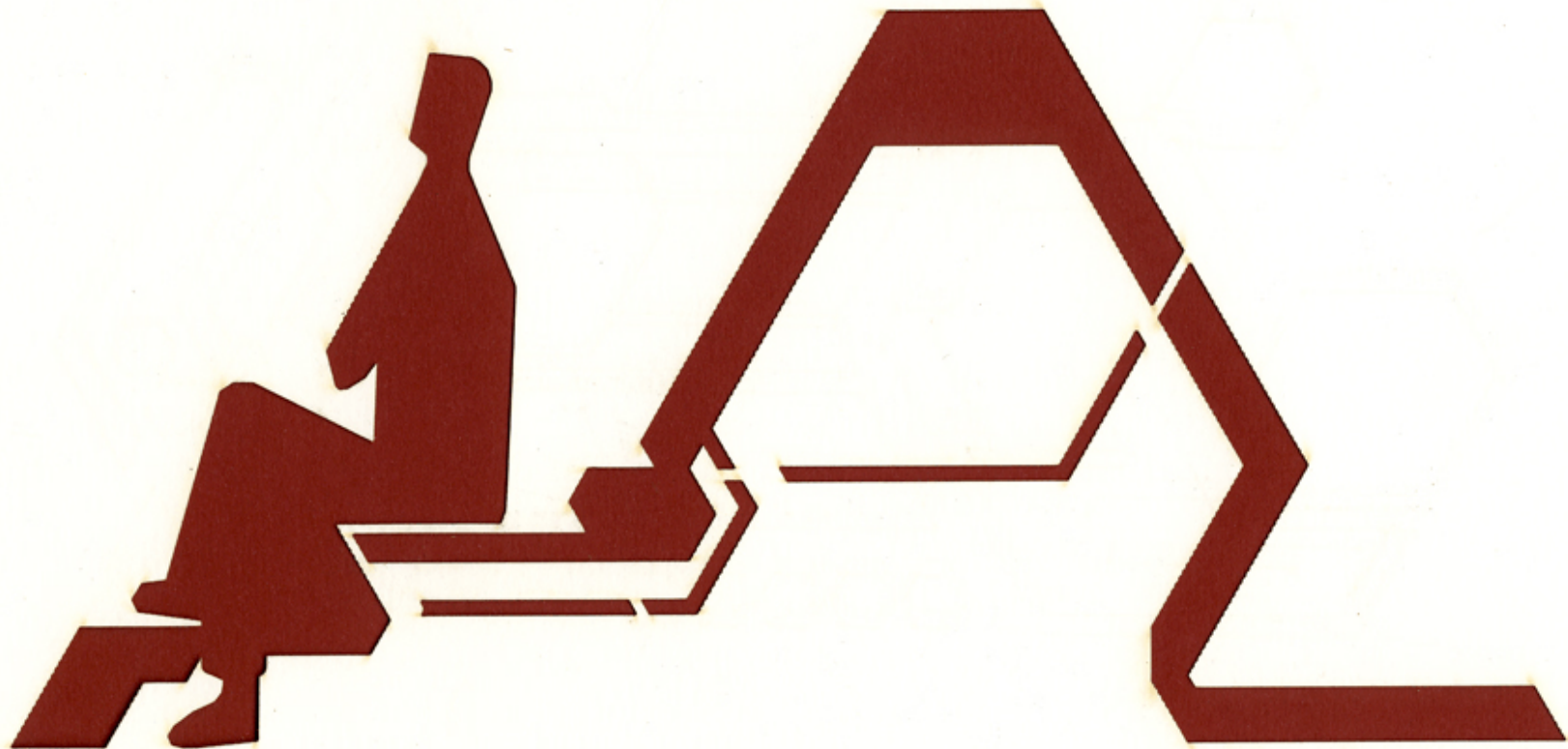

**Enkeboll Foundation for the Arts & Architecture**

Sponsored Project:

**Architectural Restoration and Conservation (ARC) of Carved-Wood Interiors**

Final Report Volume 2

Carnegie Mellon University, School of Architecture

Administrator: Laura Lee

Lead Faculty: Kai Gutschow

Date: 11 November 2005



## Teamwork

As the weeks progressed, we gathered all our work and began to organize it. We pinned up our work, made corrections and edited as we moved along in the design process. In the final phase we began to lay everything out into chapters to prepare for our final product.

**TRANSFORMATION**  
ENKEBOLL FOUNDATION  
PROJECT PHASE III

Carnegie  
Mellon  
University  
Architecture

**1.3**

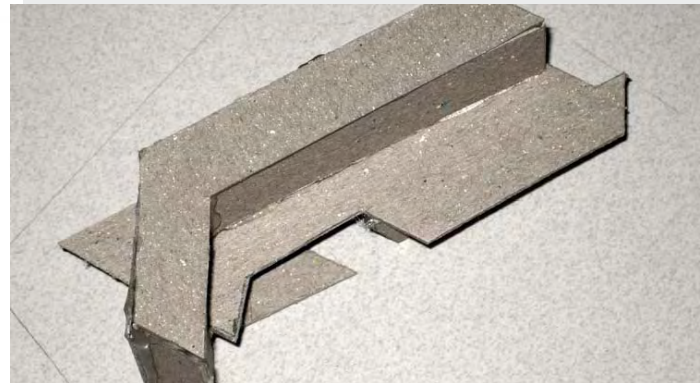
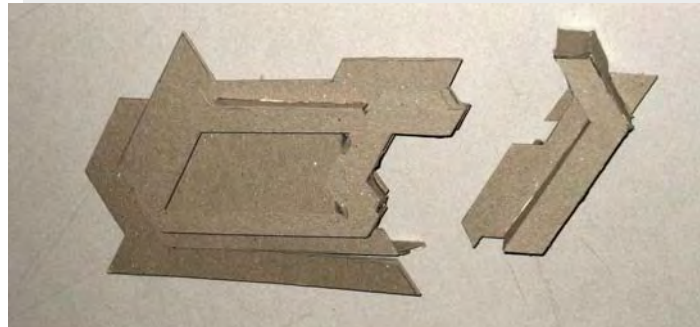
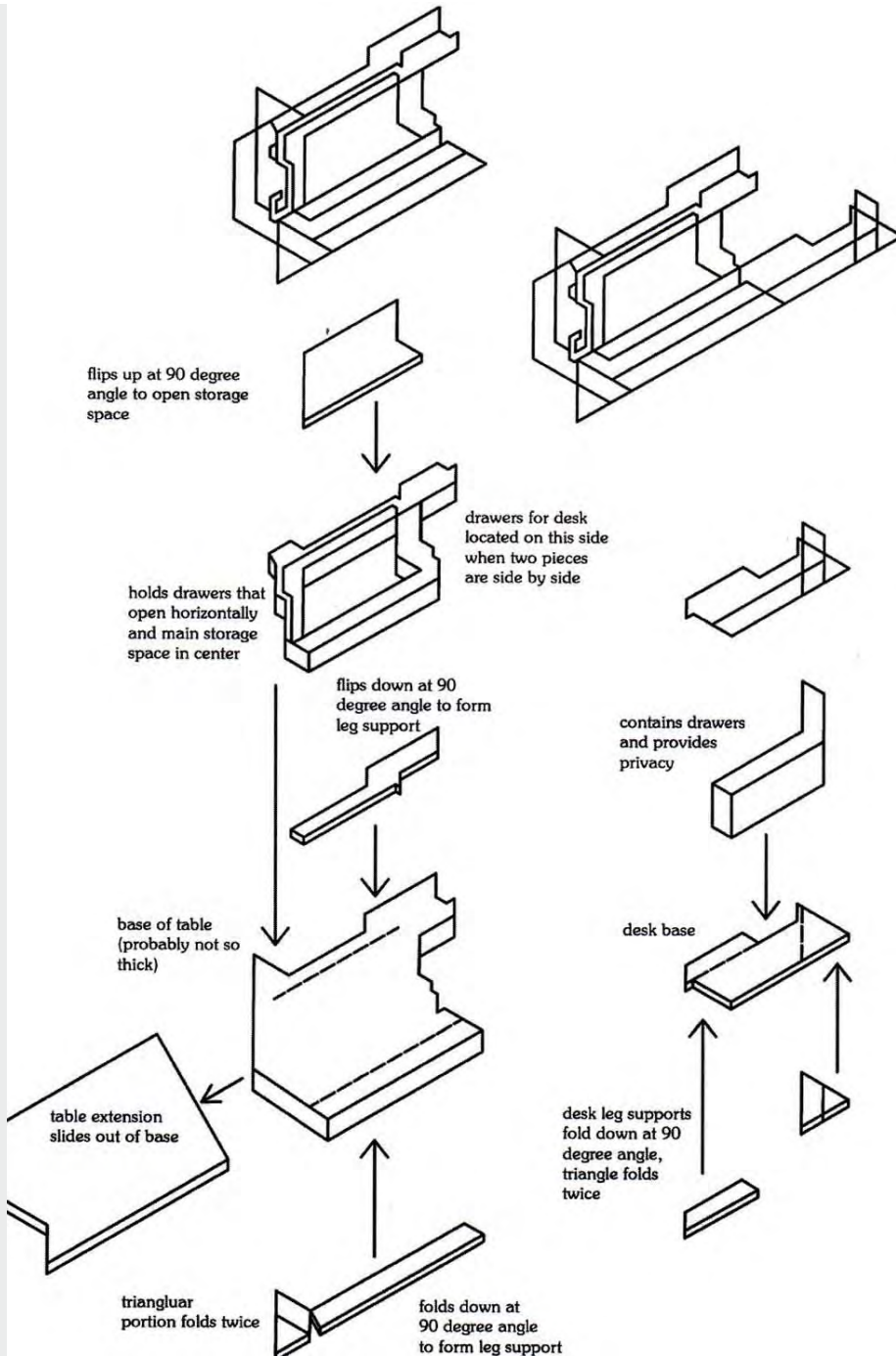

**Becky Rahmlow  
Desk and Coffee Table**

This table design demonstrates the possibilities of transforming a diagrammatic analysis of zones created by overlapping architectural experiences generated by light, materiality, height, and textures (i.e. carpet). In keeping with Wright's themes of overlapping and continuous space which can be subdivided with the addition of architectural elements into smaller spaces, this furniture design functions as multiple pieces that can serve separate functions as well as larger ones. The two-dimensional analysis creates a three dimensional form by extending, folding and extruding elements of the analysis.

**TRANSFORMATION**  
ENKEBOLL FOUNDATION  
PROJECT PHASE III

Carnegie  
Mellon  
University  
Architecture

**2.4**

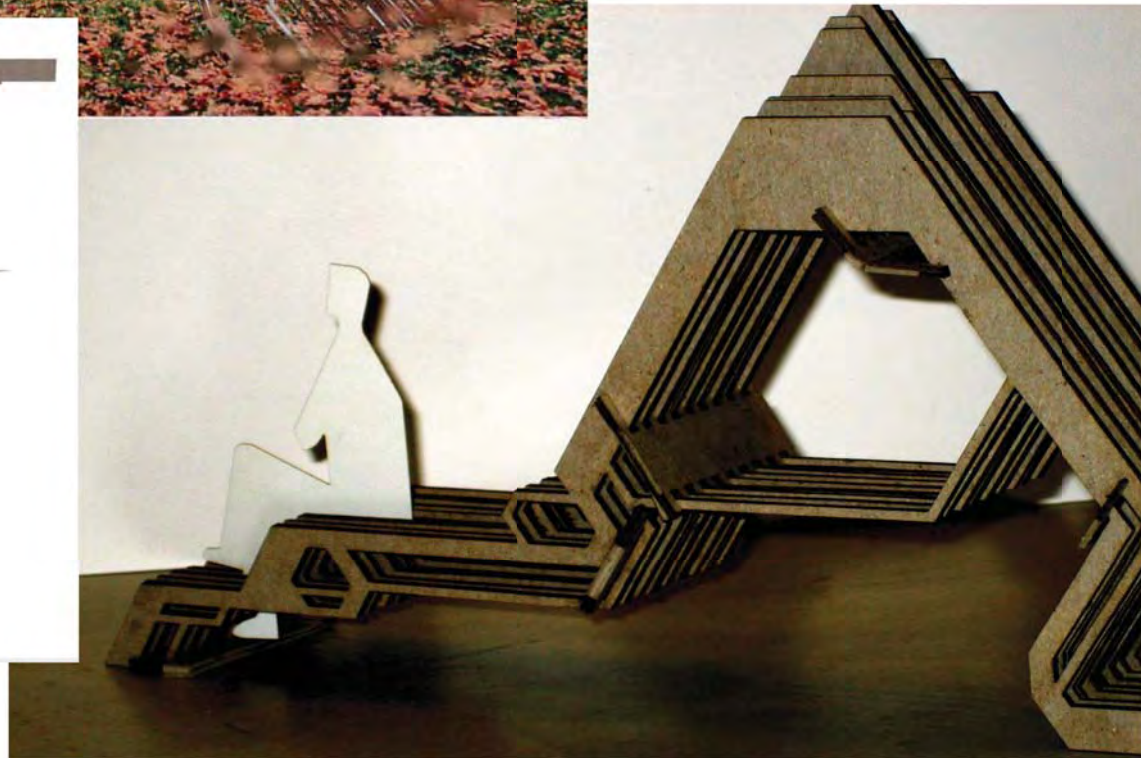
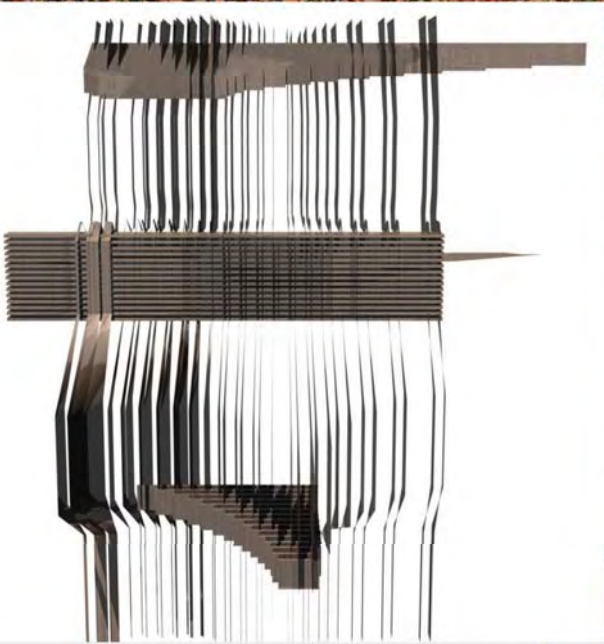
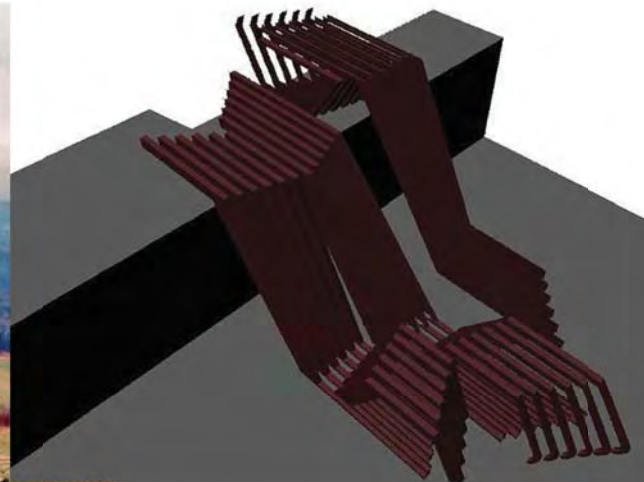

**TRANSFORMATION**  
ENKEBOLL FOUNDATION  
PROJECT PHASE III

Carnegie  
Mellon  
University  
Architecture **3.32**





final design\_the final seating area design derives its formal qualities from the manipulation of a hexagon\_\_the motion of the object allows for one seating area in the grass, enclosed by loose horizontal wood slats, and one on a cantilevered platform, made of densely positioned vertical wood slats\_the interplay of the horizontal and vertical slats is intended to give the object a dynamic quality, using the concept of point, line, and plane to give the seating area a beginning, middle, and end

**TRANSFORMATION**  
ENKEBOLL FOUNDATION  
PROJECT PHASE III

Carnegie Mellon University Architecture **4.20**



**Computer Model**

The next part of the process was to model my design using Form-Z. I used this tool to figure out the proper scale and angles for the individual pieces and to work out the mechanisms which connect them.

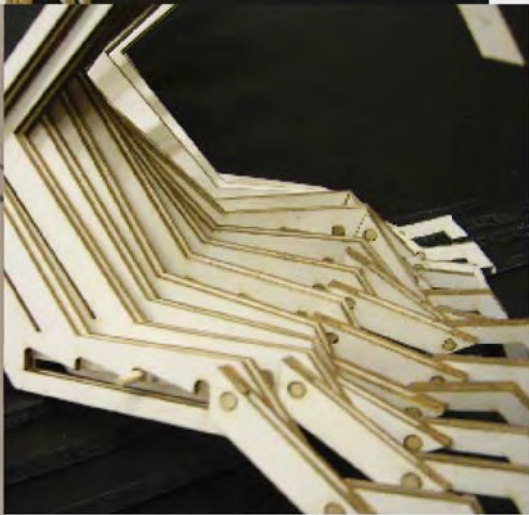
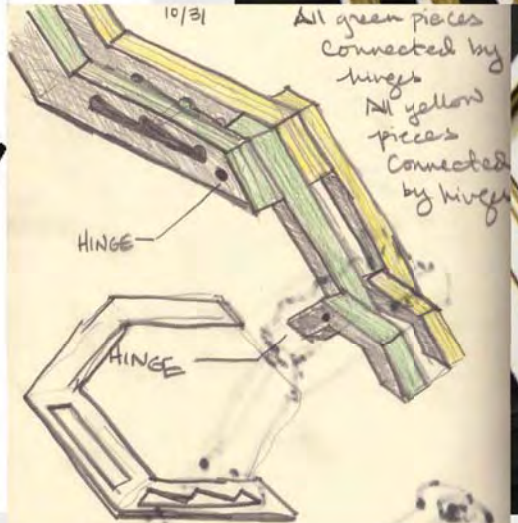

**TRANSFORMATION**  
ENKEBOLL FOUNDATION  
PROJECT PHASE III  
Carnegie Mellon University Architecture **5.17**

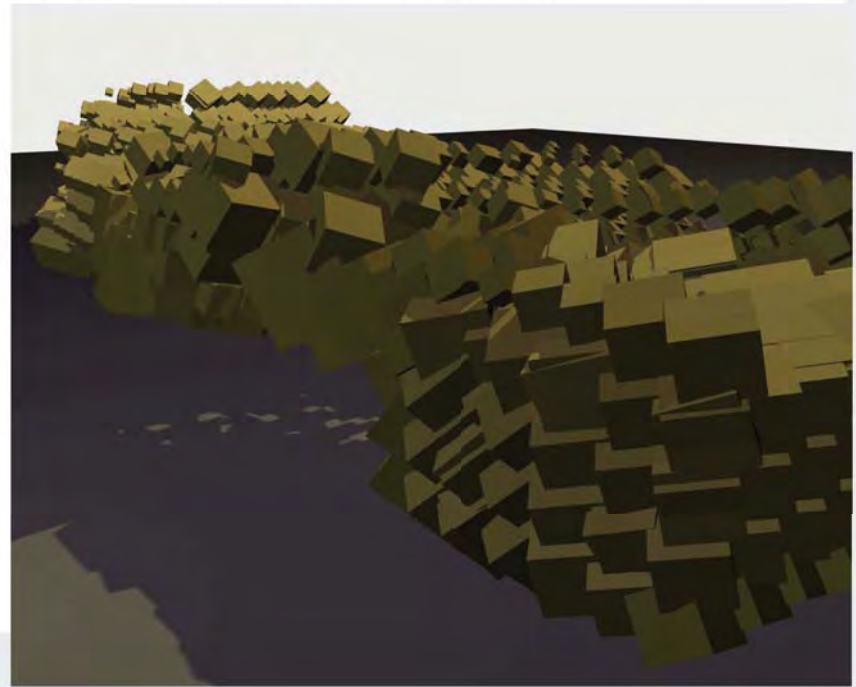
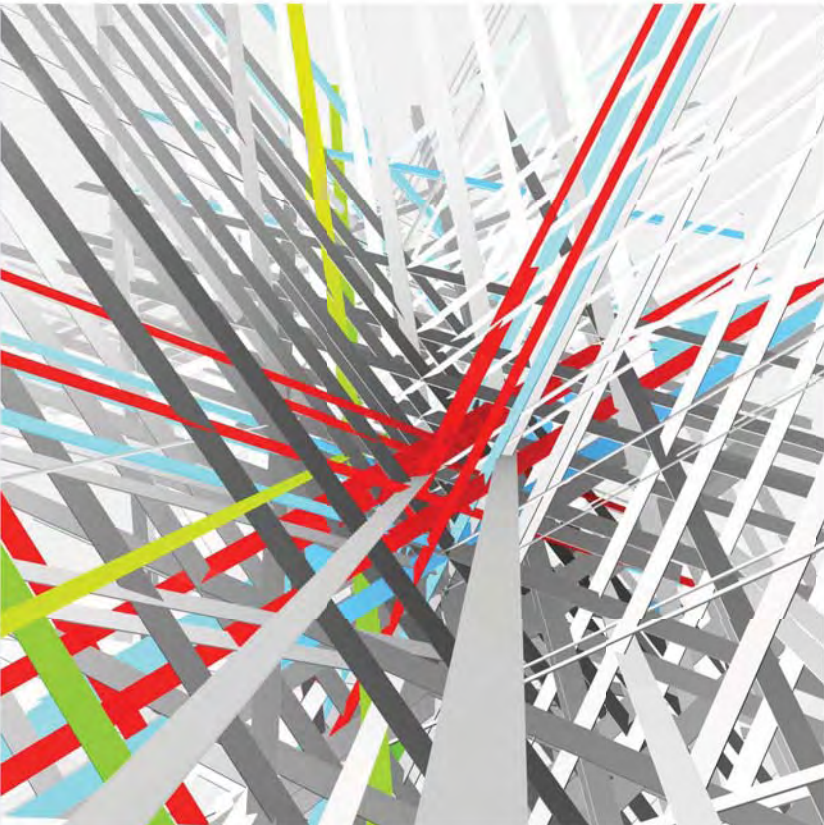
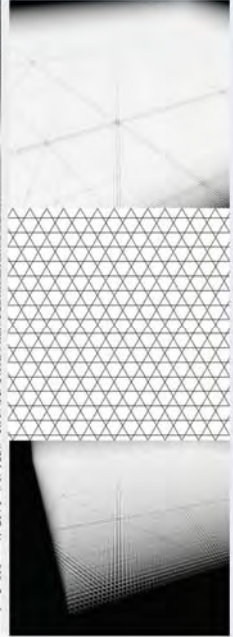
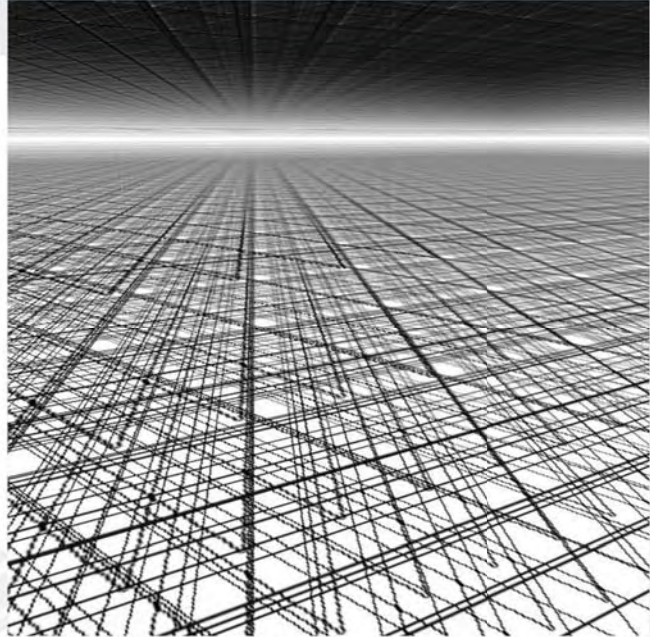
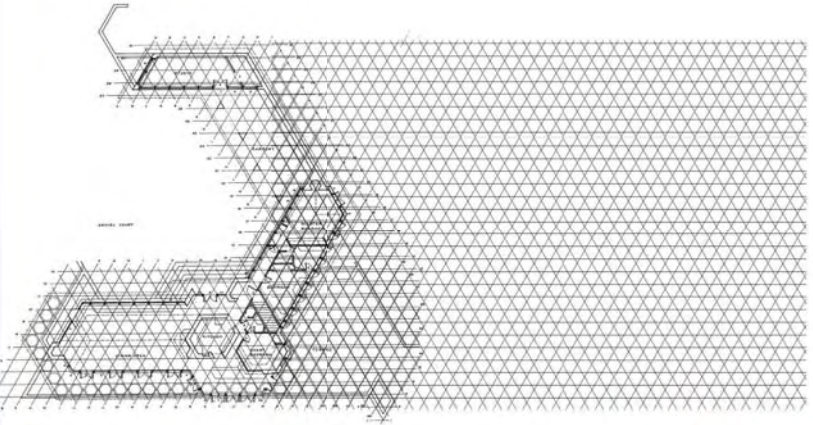

The Hexagonal grid is by far the strongest geometric characteristic of the Hagan house. However, despite its dominance, the hexagonal grid system seems only to be consistent in plan, in other words this dominant formal rigor only works on parallel 2D planes. The following series of exercises seeks to create organic form from this highly ordered and geometric system that does not refer directly to a 2D hexagonal grid.

A simple process of overlaying multiple copies of a typical hexagonal grid (right middle) gives the perceived visual sense of a three dimensional 120 degree array. This exercise raises the possibility of deriving three dimensional form from the 2D grid.